

# *Metis Coronagraph and its Implications for Space Weather Studies*

*Ester Antonucci*

*Osservatorio Astrofisico di Torino – INAF*

*ISWI Workshop*



*Trieste 20-24 May 2019*

# Solar Orbiter Mission ESA-NASA

## 2020-2030

### The Spacecraft

Three-axis stabilized spacecraft,  
Sun pointing

- Closest Sun encounter:  
0.28 AU
- Heat shield to protect spacecraft  
and payload
- Overall mass: ~1800 kg  
Maximum power demand: ~1100W
- Re-use of BepiColombo unit  
designs and technology
- NASA-provided launch vehicle
- Payload: 10 remote sensing  
instruments, 4 *in situ* instruments

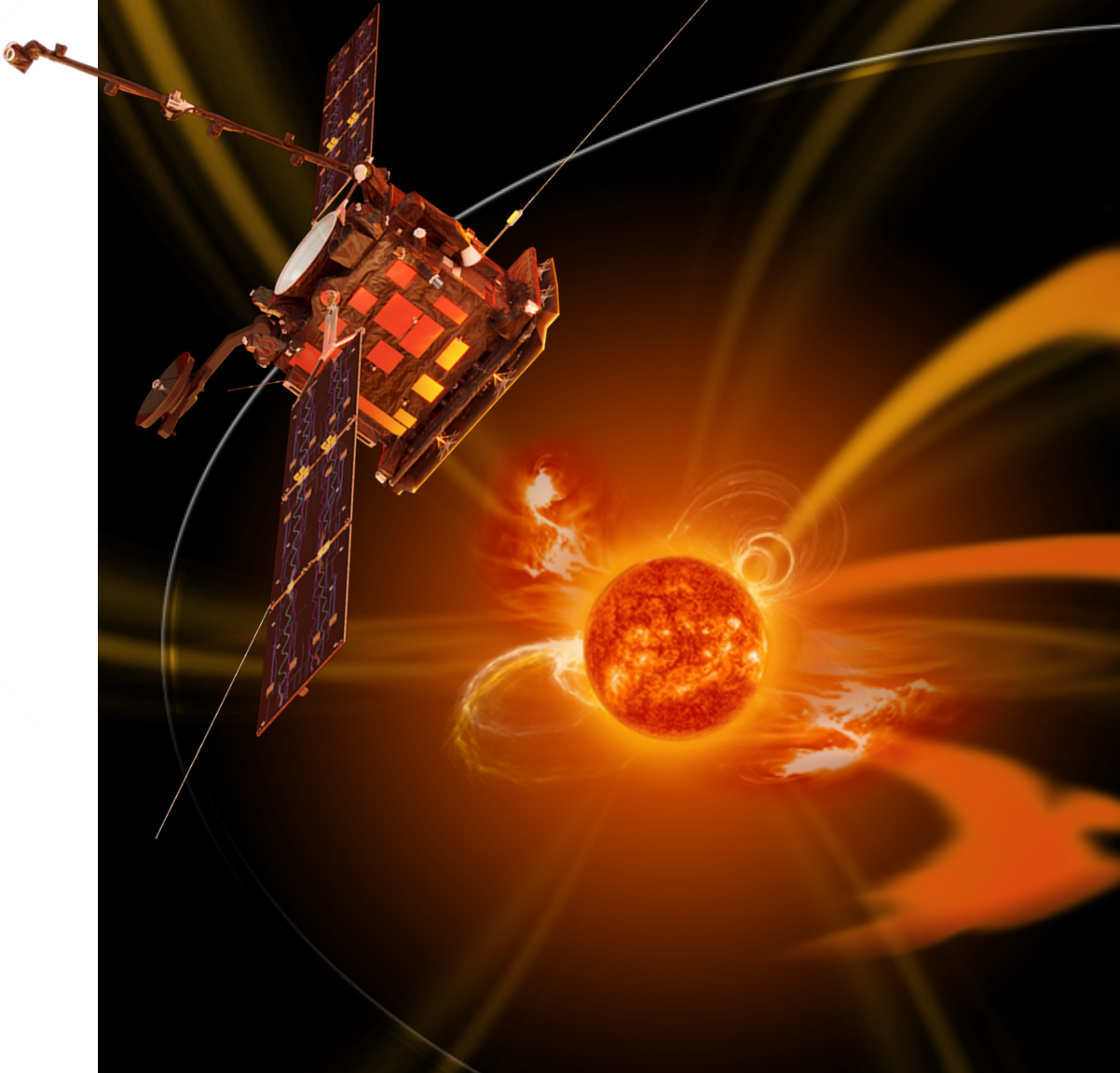

# Metis Coronagraph of Solar Orbiter

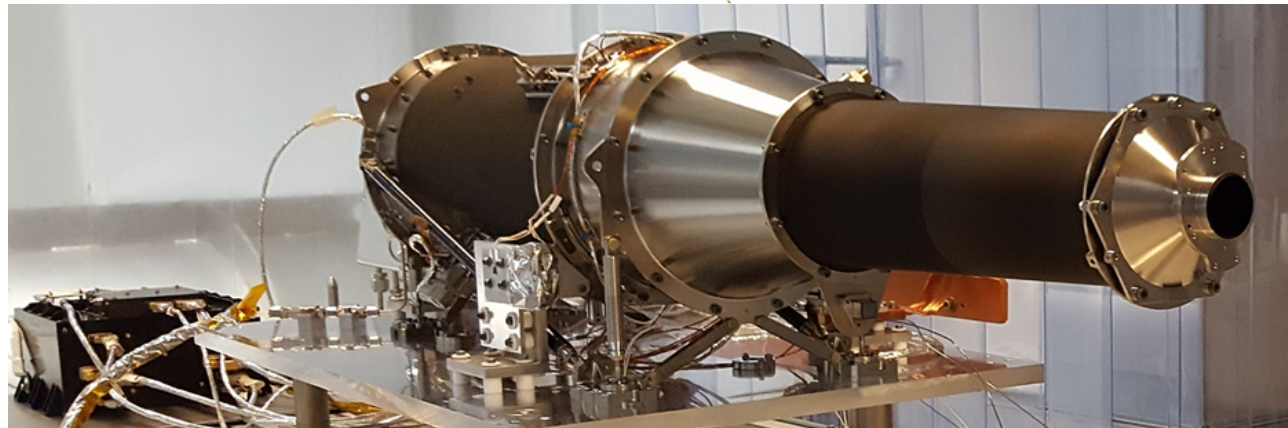
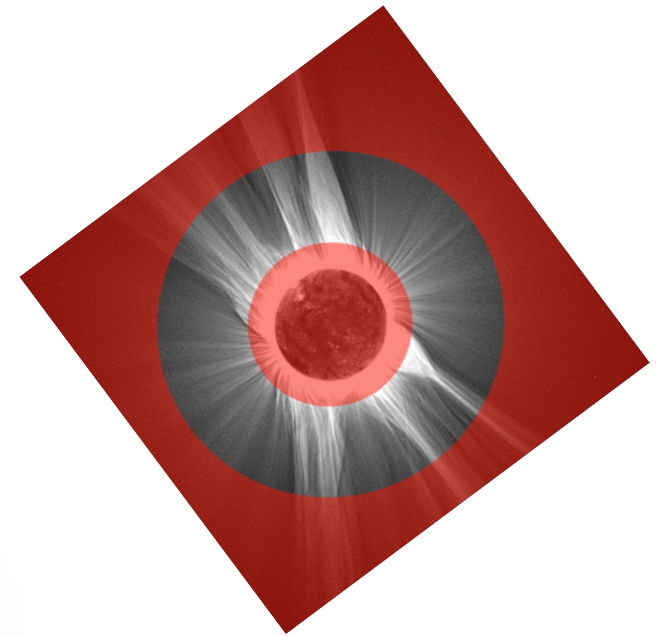
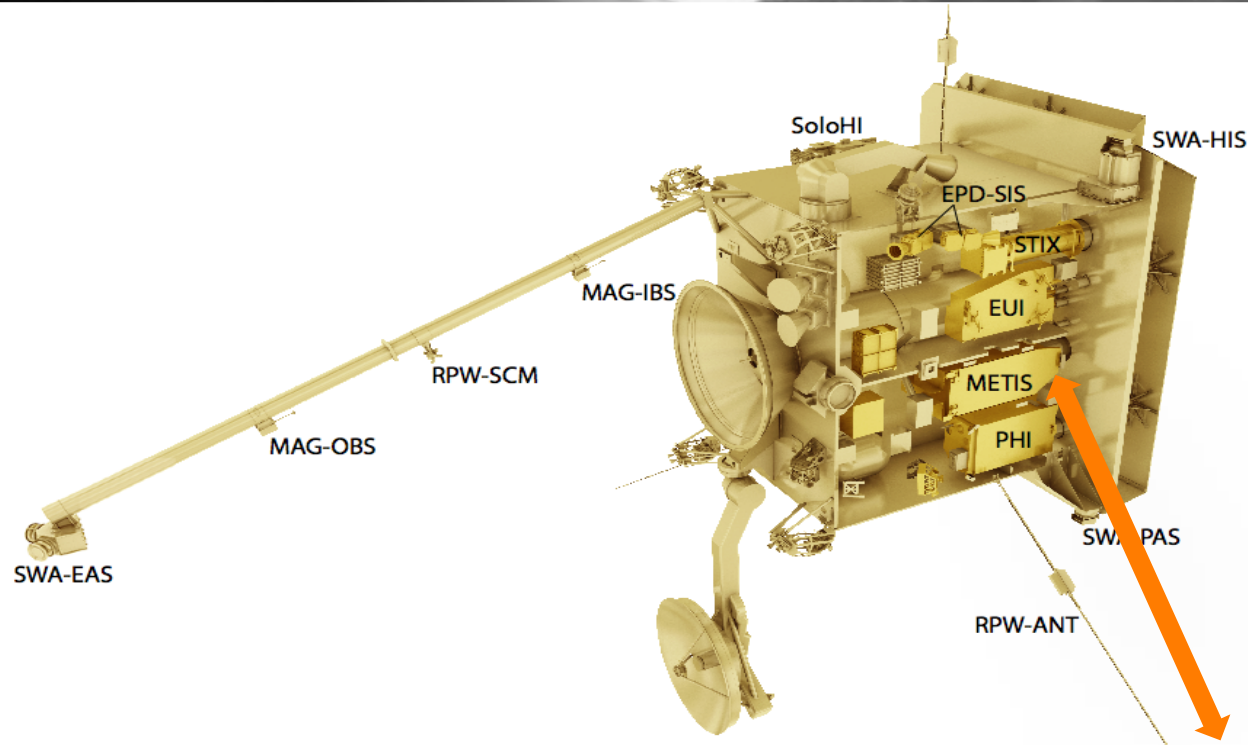

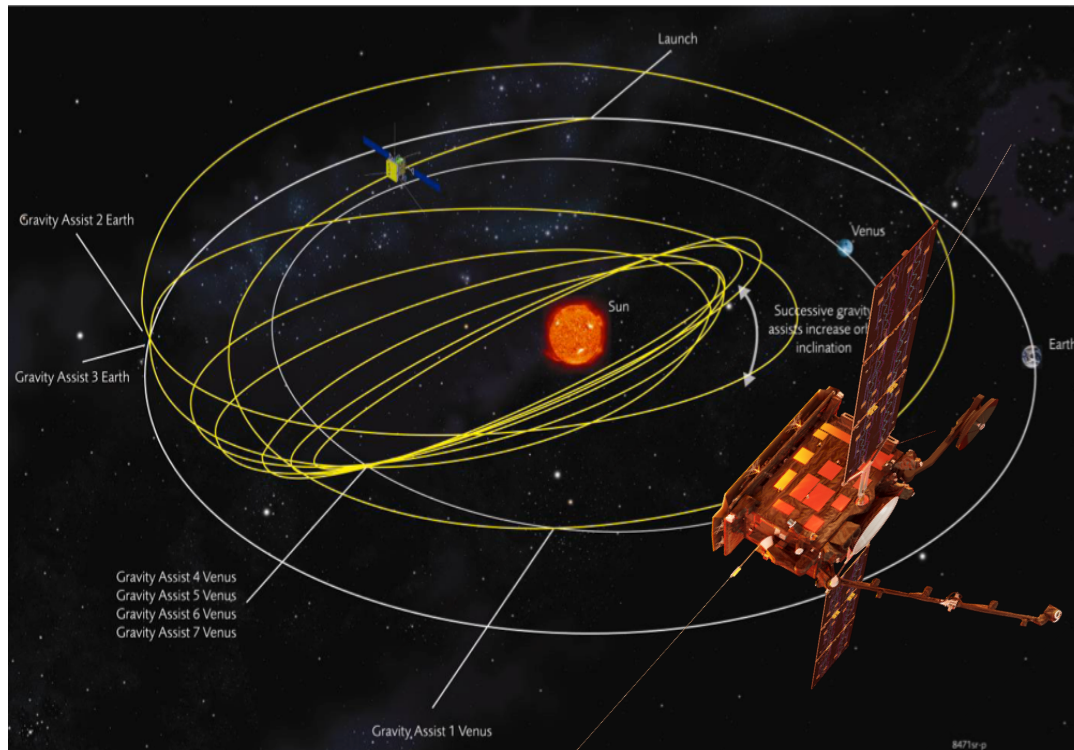

## *first visit to the Sun*

- out of ecliptic  $33^\circ$  (extended mission)
- at 0.28 AU ( $60 R_\odot$ ) (minimum perihelion)

## *first remote sensing instruments pointing*

- to the Sun at 0.28 AU

## *reduced relative motion*

- at perihelion

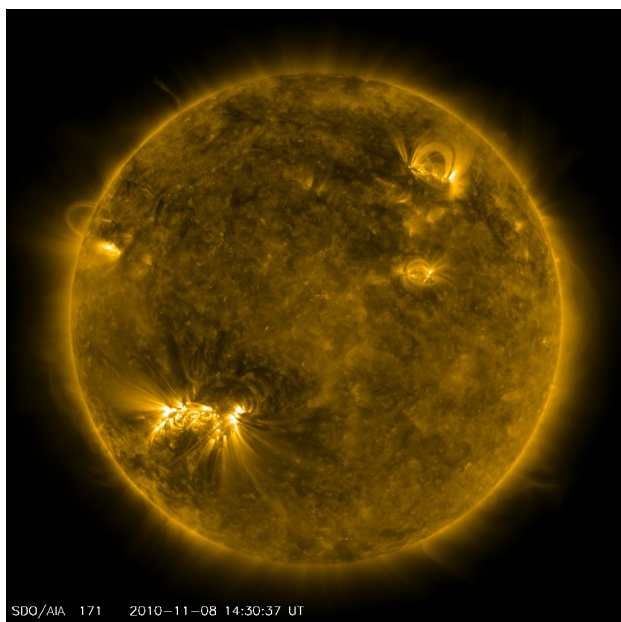

The Sun's magnetic field

Eclipse August 21, 2017  
(Predictive Science Inc. ,  
San Diego)

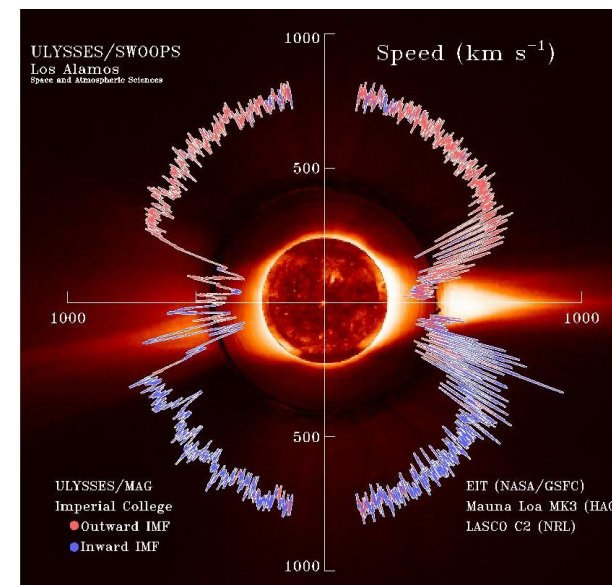
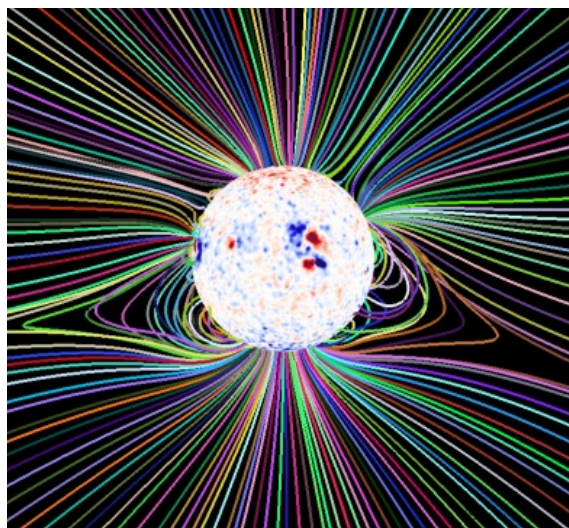

Ulysses (1992-2008)

- creates and shapes the hot corona
- guides the solar wind, due to the expansion of the hot corona, into the heliosphere along the open field lines
- its activity induces the heliospheric variability

# Solar Orbiter Mission Objective

*Solar Orbiter mission* - understanding how our nearby star

- forms the heliosphere – the magnetic shield of the solar system - with the expansion of its hot atmosphere, the  $\geq 10^6$  K corona
- perturbs the heliosphere with its moderate, cyclic magnetic activity of variable star and, in turn, the solar system planetary magnetospheres/atmospheres

*Metis coronagraph* - understanding the solar corona, source region of the main drivers of geomagnetic storms on Earth

- Solar wind (acceleration and pattern of slow and fast speed streams)
- Coronal mass ejections ( mechanisms and initial propagation)

# Metis Contribution to Solar Orbiter Science

## Solar Orbiter Science Questions

*How and where do the solar wind plasma and magnetic field originate in the corona*

*How do solar transients drive heliospheric variability*

*How do solar eruptions produce energetic particle radiation that fills the heliosphere*

*How does the solar dynamo work and drive connections between the Sun and the heliosphere*

## METIS investigates the

region where the solar wind is accelerated from about  $100 \text{ km s}^{-1}$  to approximately its asymptotic value

region where the first, crucial phase of the propagation of coronal mass ejections occurs

path of the shock front accelerating particles in the solar corona

overall magnetic configuration - closed and open magnetic field regions of the corona - inferred from solar wind outflow detection

# Metis Investigation of the Solar Corona



*First multi-wavelength imaging of the outer corona in*

- *Visible Light band 580-640 nm (polarized VL)  
Structure and evolution of electron component*
- *UV (HI Ly  $\alpha$ ) 121.6 nm  
Structure and evolution of neutral H and  
proton components*

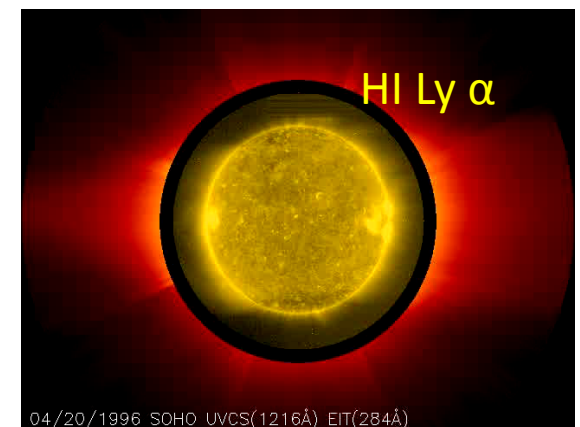
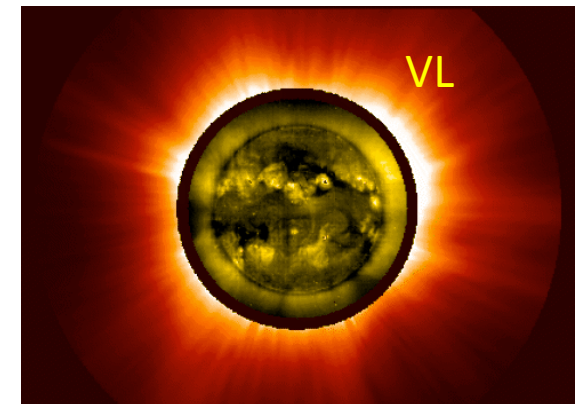

*Global dynamics of the corona and coronal wind*



# Observation of Solar Wind in the Outer Corona

- **Coronal HI Ly  $\alpha$** , observed during the 7 March, 1970 eclipse, due to resonant scattering by neutral hydrogen of the chromospheric HI Ly  $\alpha$  (Gabriel, 1971). Few residual H atoms (a few  $10^{-7}$ ) in a hot corona ( $10^6$  K), but abundant hydrogen, and strong chromospheric HI Ly  $\alpha$  emission
- **Doppler dimming** of resonantly scattered emission in a moving system of reference (Beckers and Chipman, 1974): the **diagnostic technique to measure coronal expansion**, i.e. to detect solar wind outflows in the outer corona (G. Noci, proposal to SAO for the development of UV coronagraphs, early 70s)
- First application of UV spectrometry-coronagraphy to observe the extended corona with **UVCS/SOHO** during **activity cycle 23** (1996- 2013) (Kohl et al. 1997, 1998, etc.)

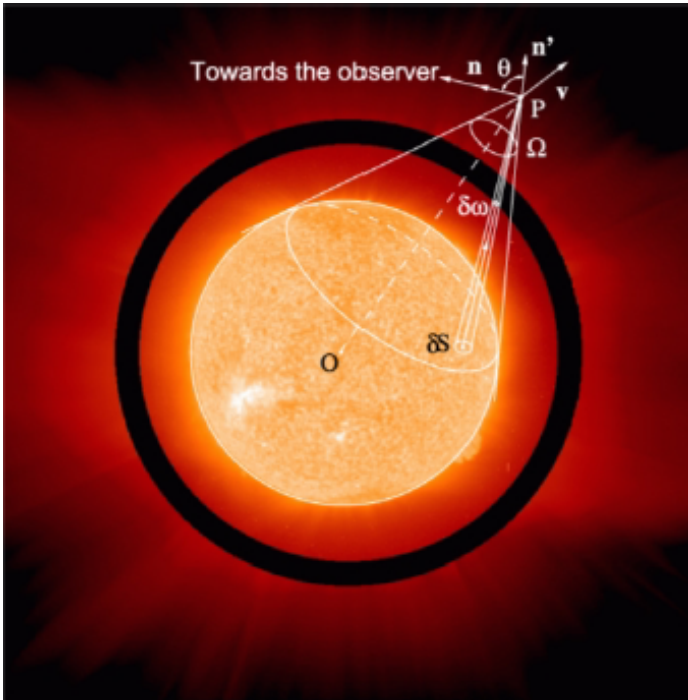

$$I_{\text{rad}} = \frac{0.83}{4\pi} b h \lambda_0 B_{12} \int_{\Omega} p(\phi) d\omega \int_{l.o.s.} \Phi(\delta\lambda) A_{el} R_{ion}(T_e) n_e dl$$

$$\delta\lambda = \frac{\lambda_0}{c} w \cdot n'$$

*Doppler dimming* due to a reduction of the intensity of the resonantly scattered component of the spectral line which depends on the *outflow velocity*  $w$  of the coronal plasma.

# Doppler Dimming of the Resonantly Scattered $H\text{I Ly}\alpha$

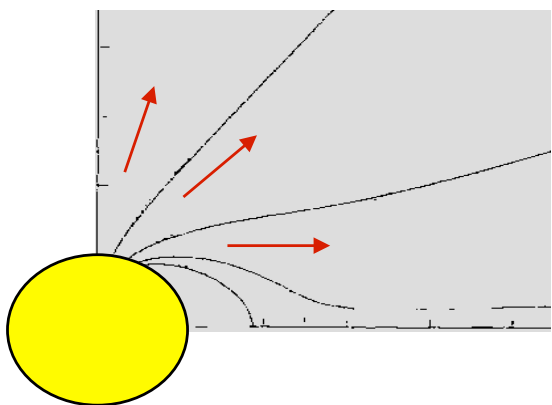
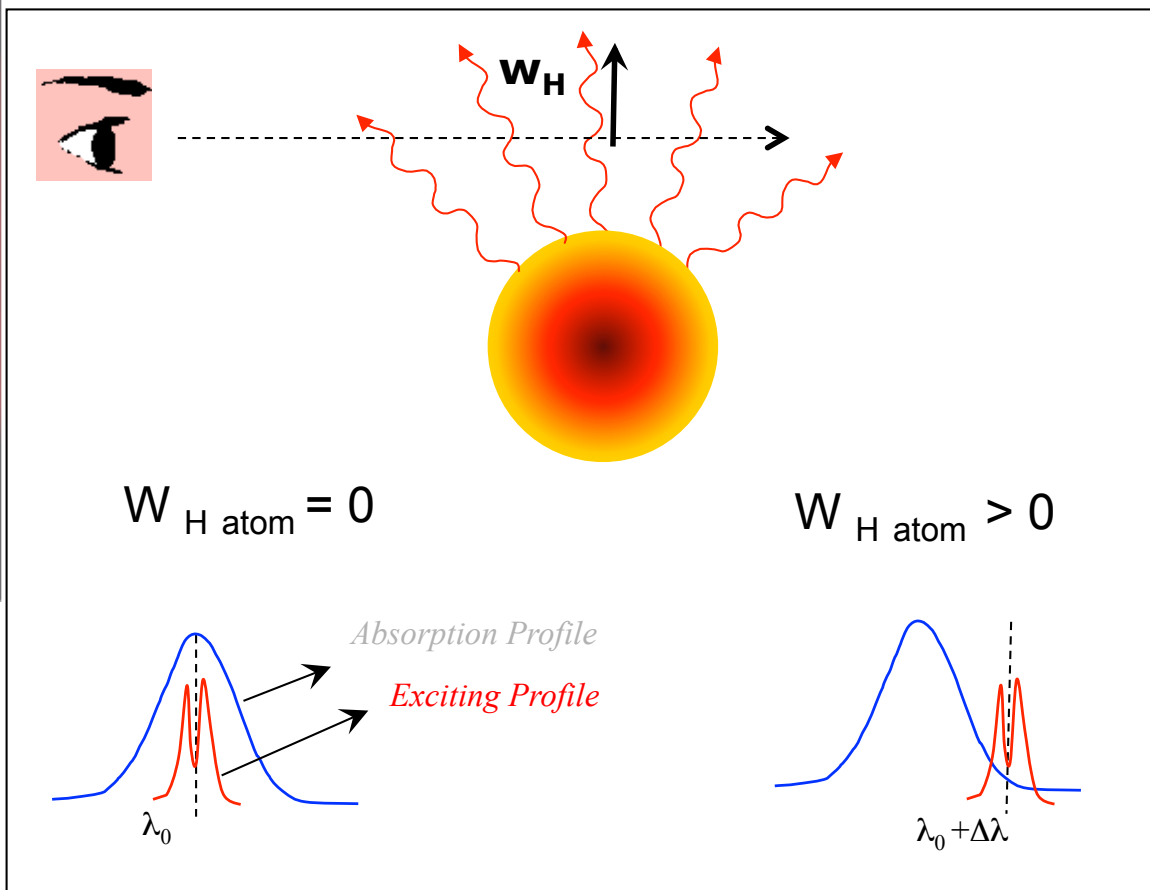
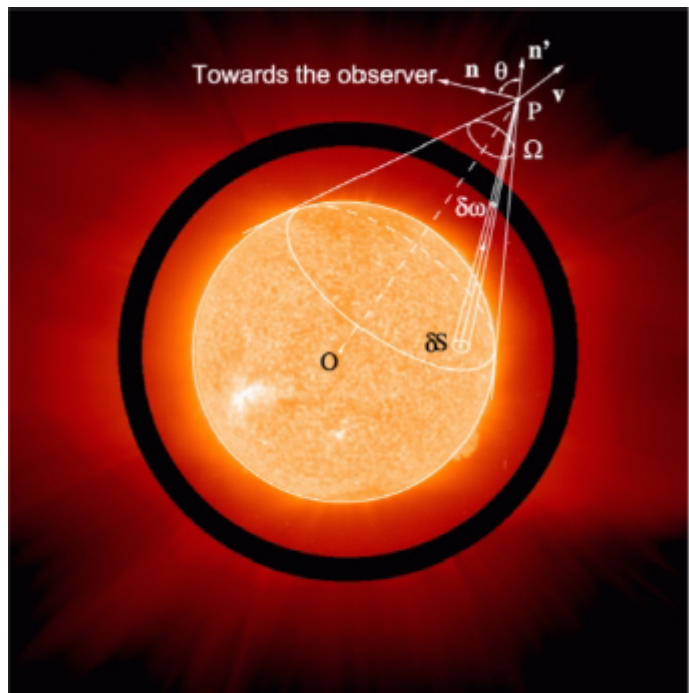

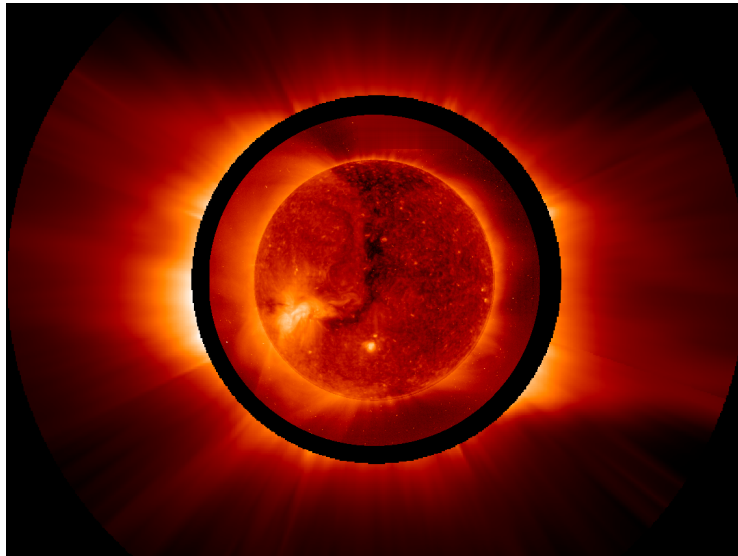

*Detection of solar wind in the corona with UVCS  
SOHO (Kohl et al. 1997, 1998)*

*Coronal signatures of the solar wind*

- outflow velocity and acceleration
- kinetic temperatures ( $T_k$  perpendicular to B)
- ion velocity distribution anisotropy

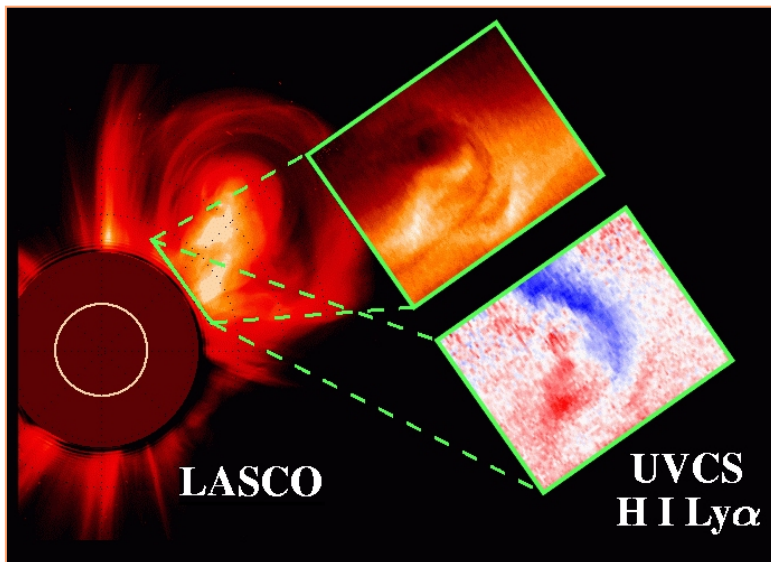

*Spectroscopy of the coronal mass ejections*

- Thermal structure of coronal mass ejections
- Plasma parameters at the shock front
- Plasma parameters at the reconnection region

# First Outflow Velocity and Kinetic Temperature with UVCS



$100 \text{ km s}^{-1}$  countour (OVI doublet ratio)

*Solar minimum cycle 22*  
*Super-synoptic 19 Aug-1 Sep 1996*  
*UV outer corona :  $1.5 - 3.8 R_{\odot}$*

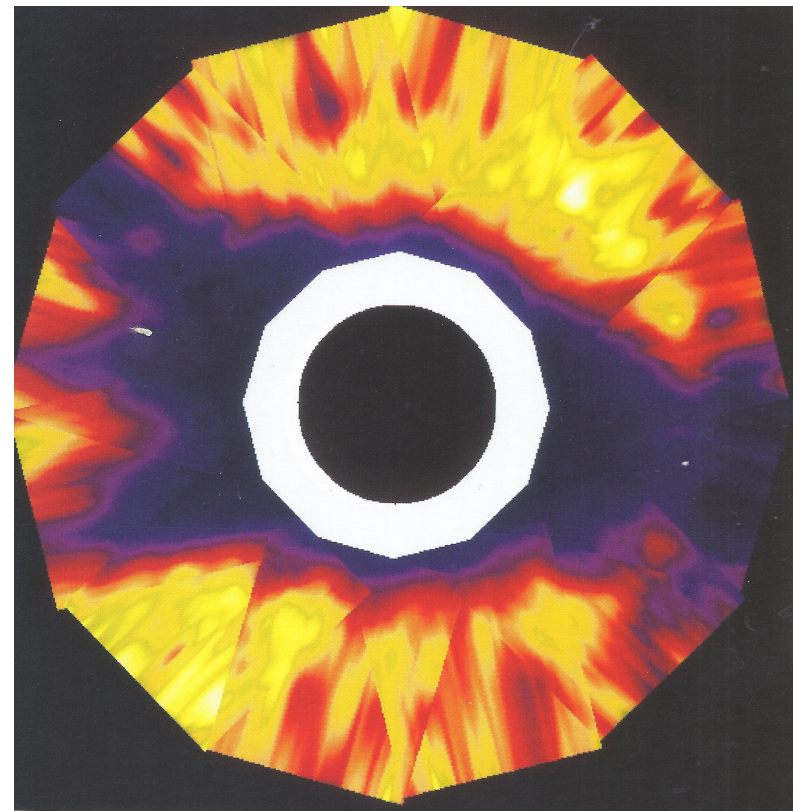

*Kinetic temperature of the Oxygen ions (up to  $10^8 \text{ K}$ )*

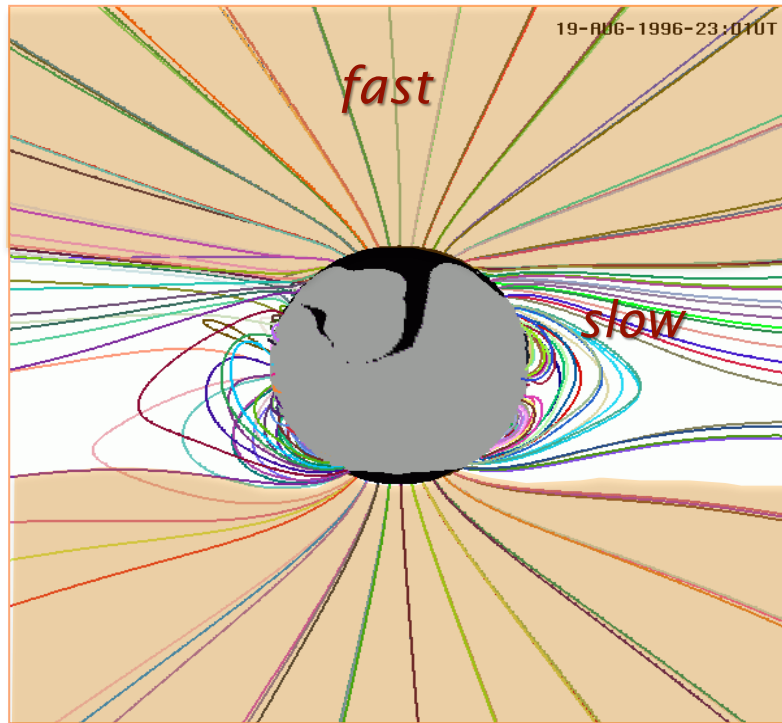

Coronal wind (UVCS/SOHO)

(McComas et al. 1998)

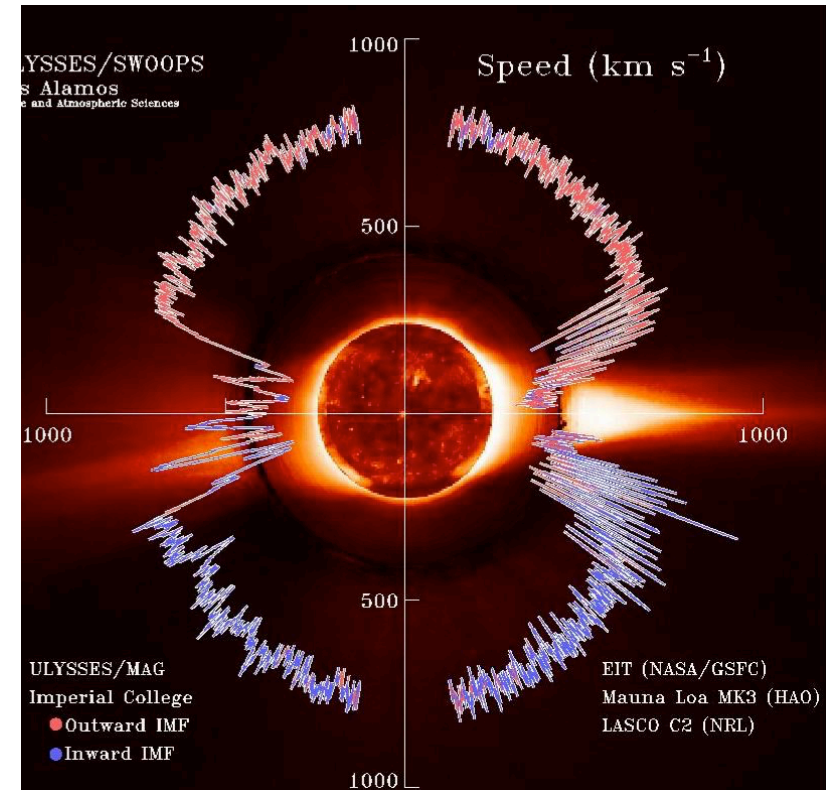

Heliospheric wind (Ulysses)

*Open field lines channel toward the heliosphere the fast and slow wind streams structuring the heliospheric wind patterns*

# UVCS-SOHO Coronal 'Images'

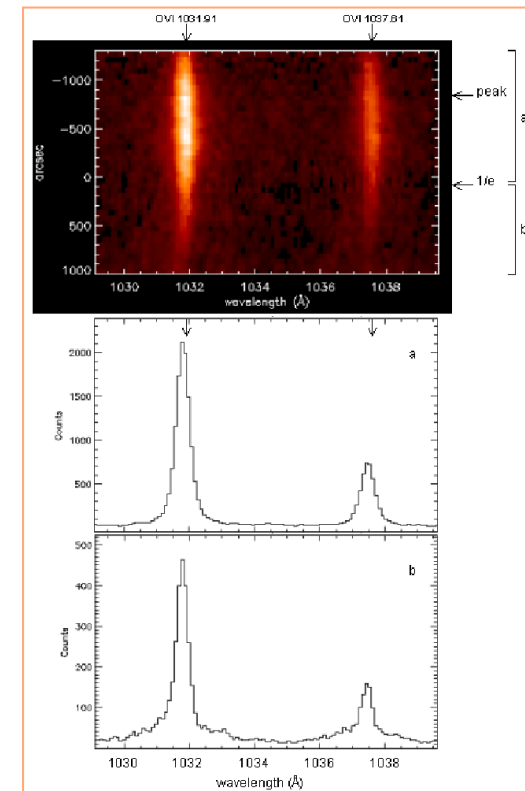
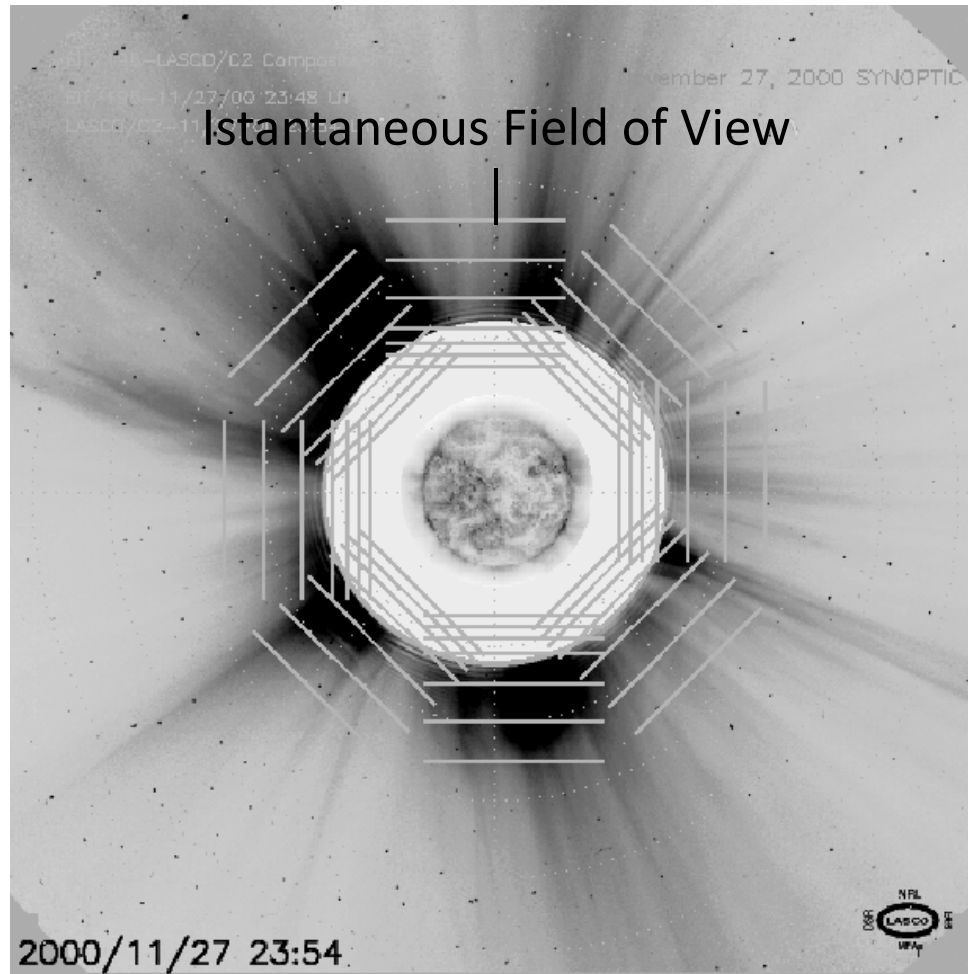

UVCS images derived from spectroscopic observations performed in IFOVs  
(synoptic data acquired over  $\approx 10$  h)

# Proton Component Outflow Detection



UV HI Ly $\alpha$  image, e.g.  
derived from UVCS –  
SOHO observations

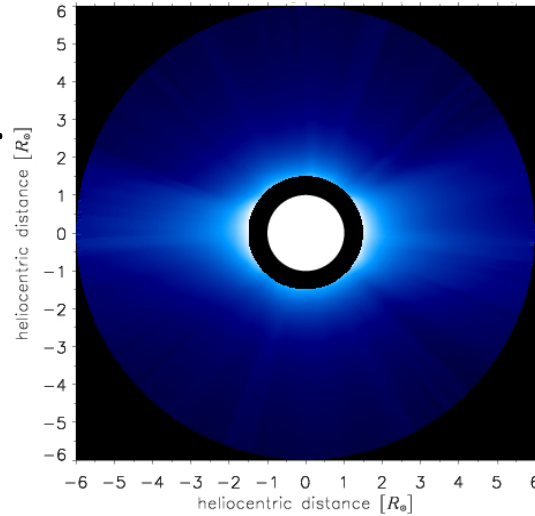

UV HI Ly $\alpha$ , e.g.  
synthesized image of  
a *static corona* using  
Pb data obtained with  
LASCO-SOHO images

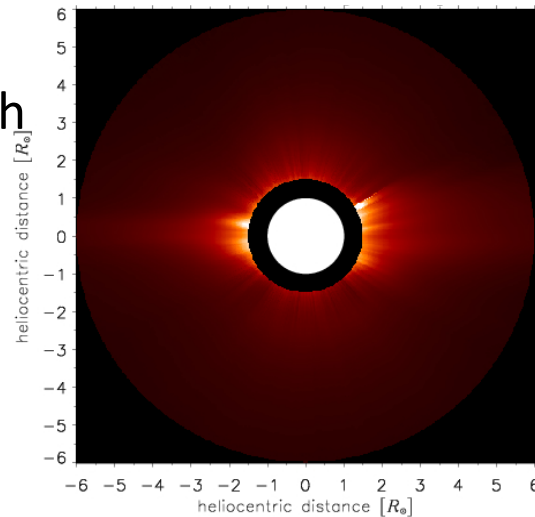
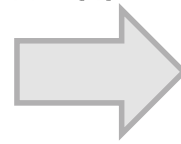

To derive 2D map on the  
plane of the sky of the  
speed of coronal plasma  
outflows



*Metis multi-wavelength imaging of the extended corona (1.7 – 9  $R_{\odot}$ )  
Simultaneous imaging in*

- *Visible Light band 580-640 nm (polarized VL)*
  - *UV (HI Ly  $\alpha$ ) 121.6 nm*
    - high temporal resolution  $\geq 1$  sec ( $\geq 1$  min)*
    - high space resolution  $\geq 2000$  km VL*
      - $\geq 15000$  km UV*
- to study coronal dynamics*

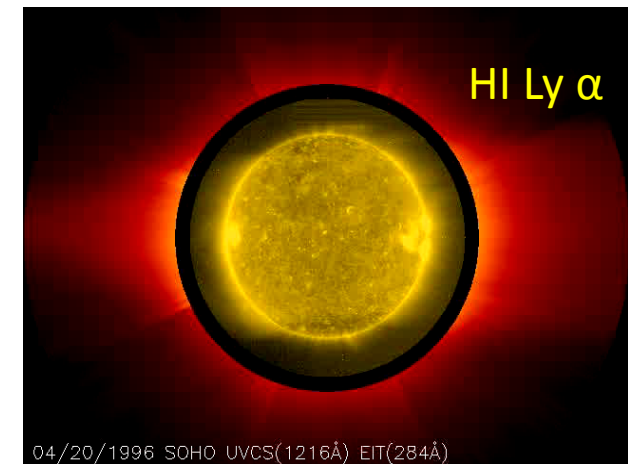
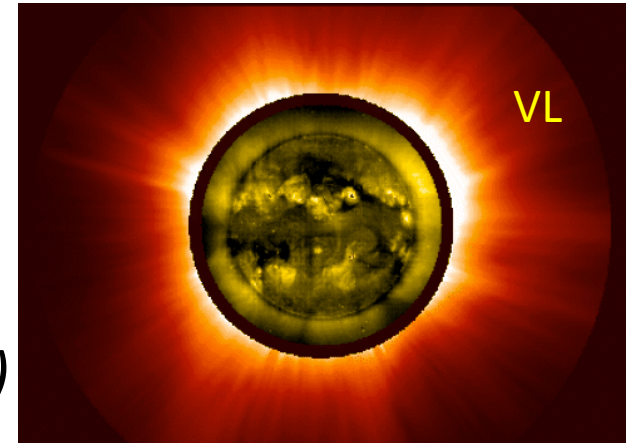

# SCORE Multi-wavelength Coronagraph Prototype



Simultaneous VL and UV images acquired only during HERSCHEL rocket flight  
(Sep 2009)

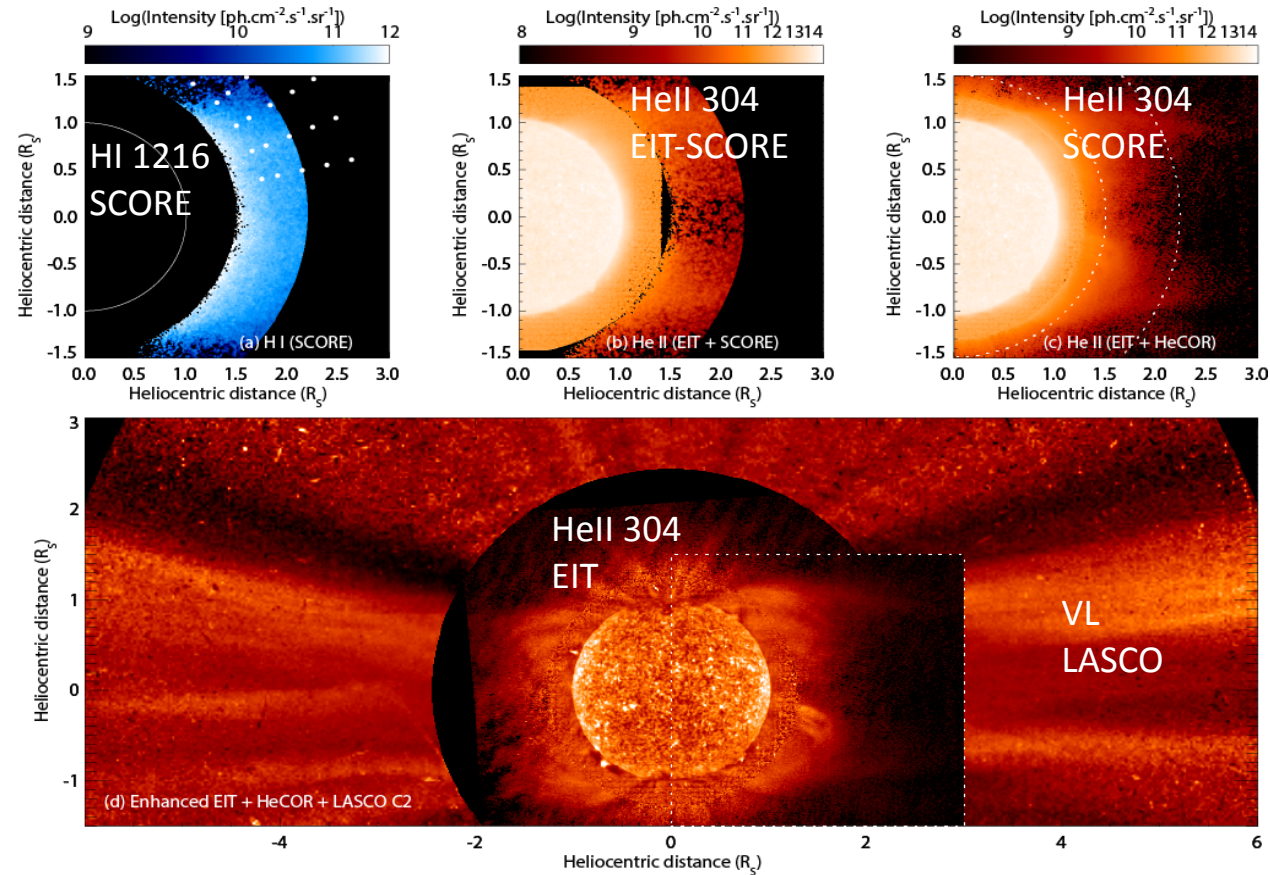

- UV Herschel observations with EIT and SCORE (NRL, IAS, INAF)
- VL data with ground-based instrumentation (Mark IV HAO, LASCO)

## METIS

## Achievable Scientific Performance

## Solar Orbiter Core Science

### UV&VL imaging

*Present Visible Light imaging coronagraphy*

Measure the electron density in the solar corona and its longitudinal distribution

### **Solar wind**

Identify the coronal wind and measure its parameters:

- velocity to discriminate fast and slow wind
- acceleration to locate energy deposition in corona
- mass and energy flux
- longitudinal distribution fast and slow streams

Observe the coronal density fluctuations, and assess their role in the acceleration of the solar wind

Trace, through the flows, the open coronal magnetic field and the overall magnetic topology

### **Solar wind origin and acceleration**

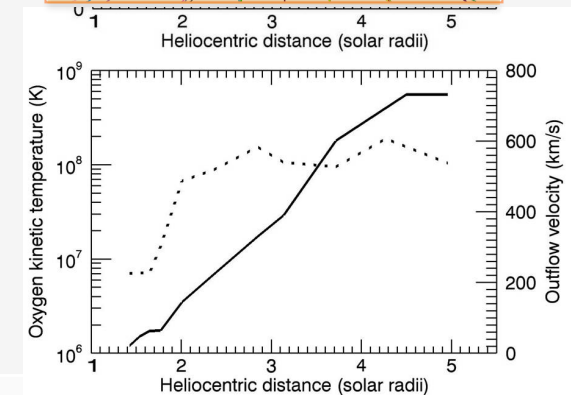
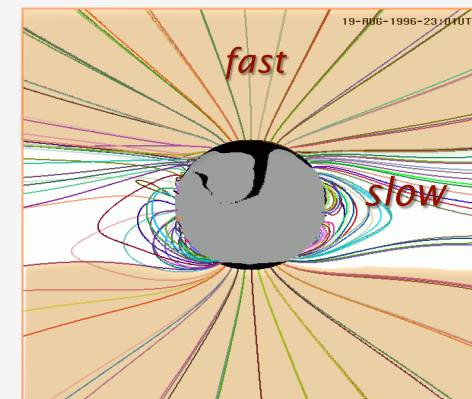

**METIS**

**Achievable Scientific Performance**

**Solar Orbiter  
Core Science**

**UV&VL  
channel**

**Coronal mass ejections**

Measure the

- temporal evolution
- mass content
- overall dynamics
- directionality to infer its geo-effectiveness
- longitudinal distribution

of the plasma erupted from the Sun.

Identify the shock front where particles can be accelerated

**Solar Coronal Mass Ejections origin and propagation**

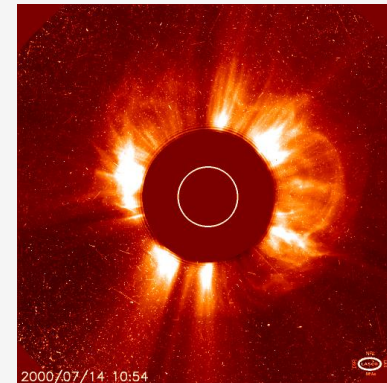

**Acceleration of energetic particles  
Prominence activity**

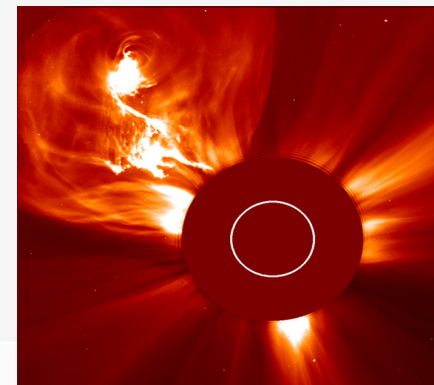

*Close to the Sun 0.28 AU (minimum perihelion)*

Coronal fine structure at all latitudes & longitudes ( $0^{\circ}$ - $33^{\circ}$  inclination)

*Out of the ecliptic  $\geq 33^{\circ}$*

Third dimension of solar wind (magnetic topology) coronal structure and CME's

*Quasi-Corotation*

intrinsic evolution of the corona cancelling rotation effects

e.g. coronal fluctuations, slow wind origin, streamer physics, evolution of configuration prior and post CMEs

*Out of the geocorona*

Best UV coronal seeing conditions

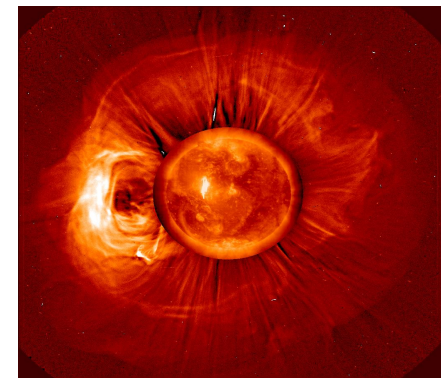



solar orbiter

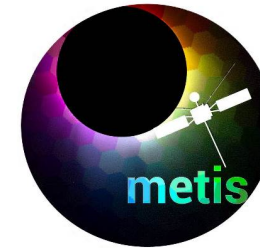

ASI – INAF



MPS



AIAS

Metis flight model

## Requirements

- low mass
- low power
- thermally robust
- radiation proof

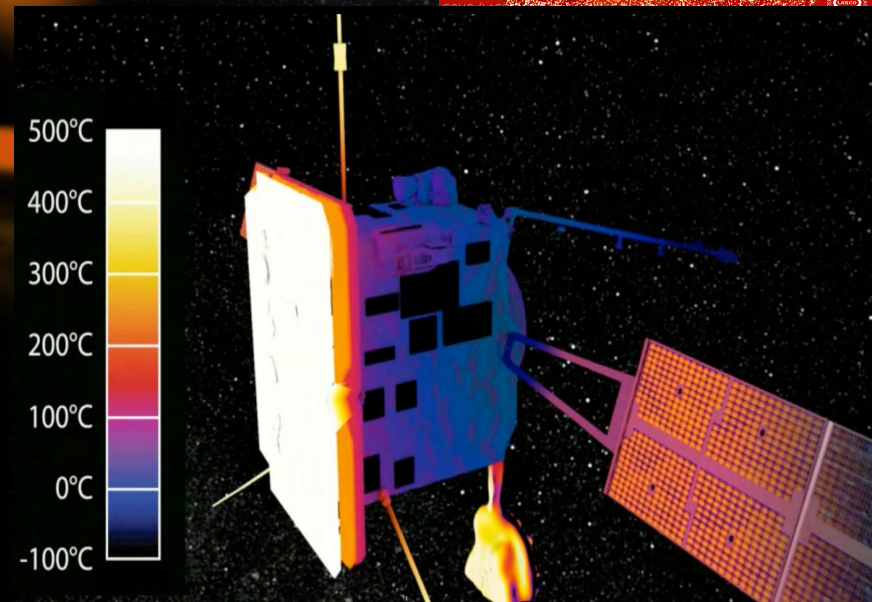
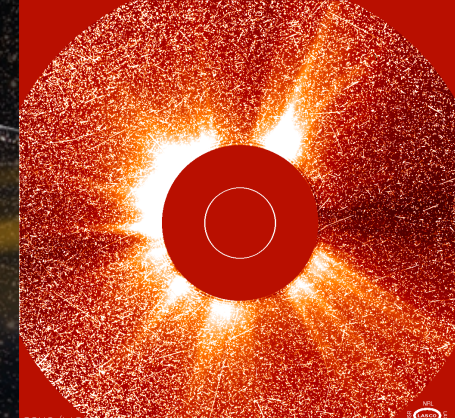

## Externally occulted coronagraph

- Annular FOV: 1.6°-2.9°  
(1.7-3.1  $R_{\odot}$  @ 0.28 AU)

## Simultaneous imaging in 2 channels

- broad-band polarized visible light (580-640 nm)
- narrow-band UV @ Lyman  $\alpha$  (121.6 $\pm$ 10 nm)

## Spatial resolution

- $\leq 20''$  (VL & UV phot. count.)  $\rightarrow$  2000 km @ 0.28 AU
- $\geq 80''$  (UV analog mode)  $\rightarrow$  15000 km @ 0.28 AU

## Temporal resolution

- $\geq 1$  min typically
- 1 s (VL only, coronal fluctuations)
- Possibility of CME-triggered obs.

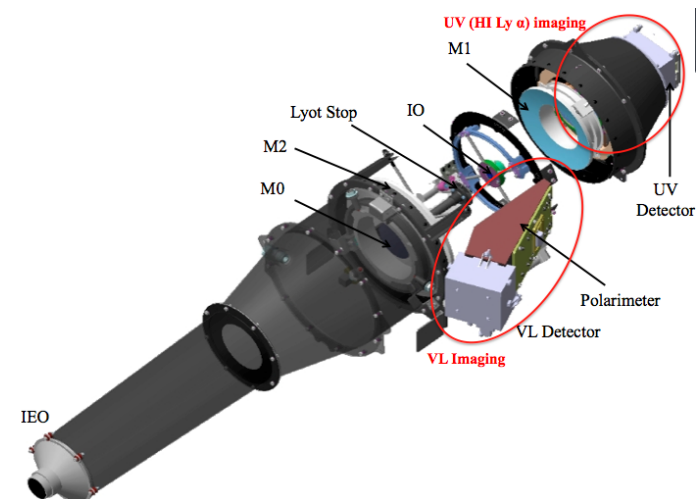
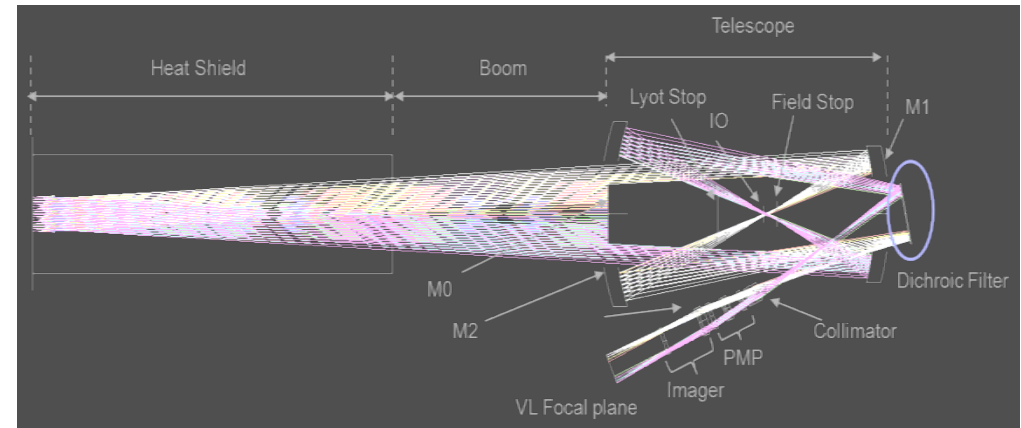



# METIS Optical Design

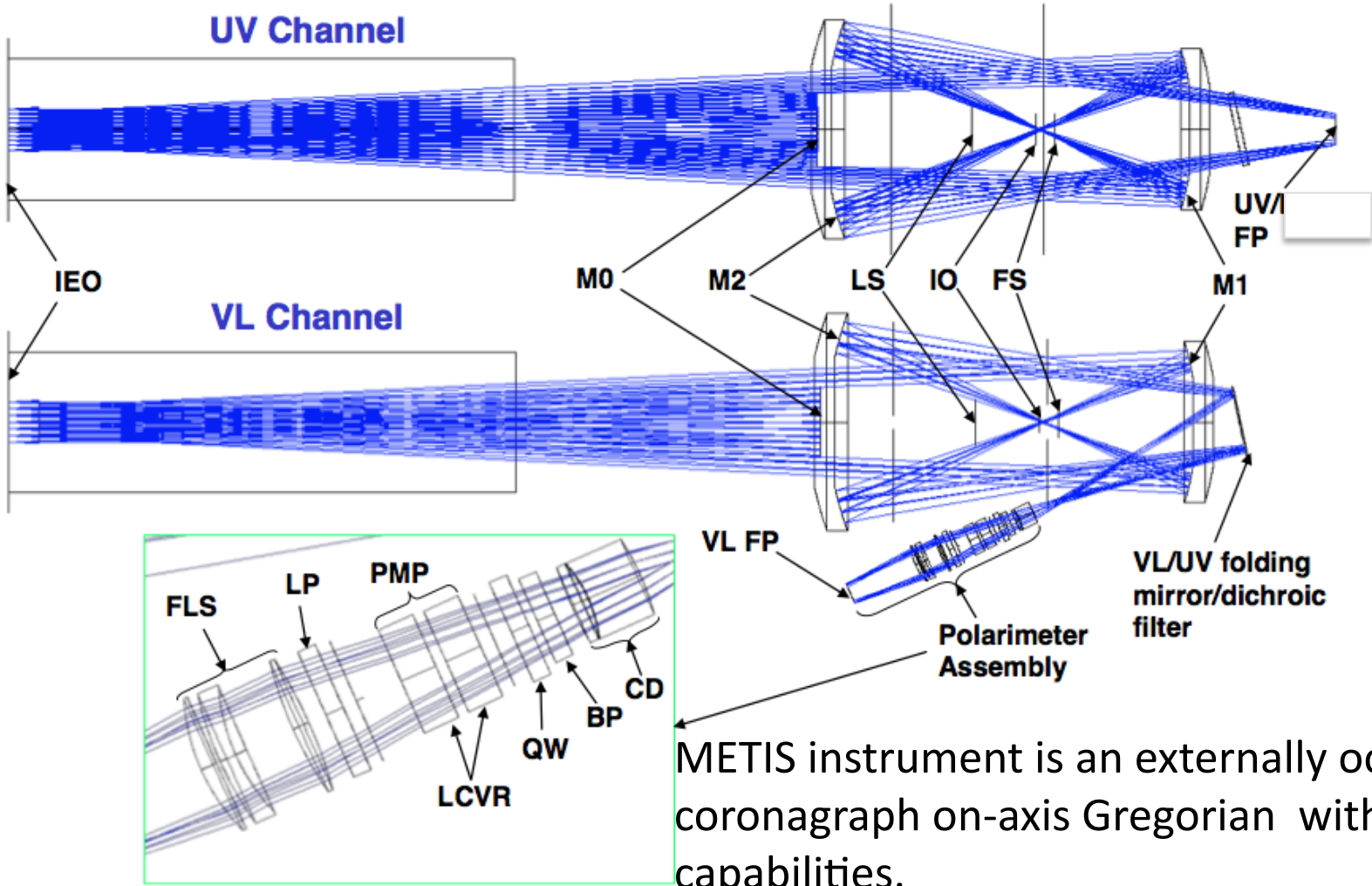

METIS instrument is an externally occulted coronagraph on-axis Gregorian with imaging capabilities.

Polarimetry performed with liquid crystal retarders

# Metis Opto-Mechanical Layout

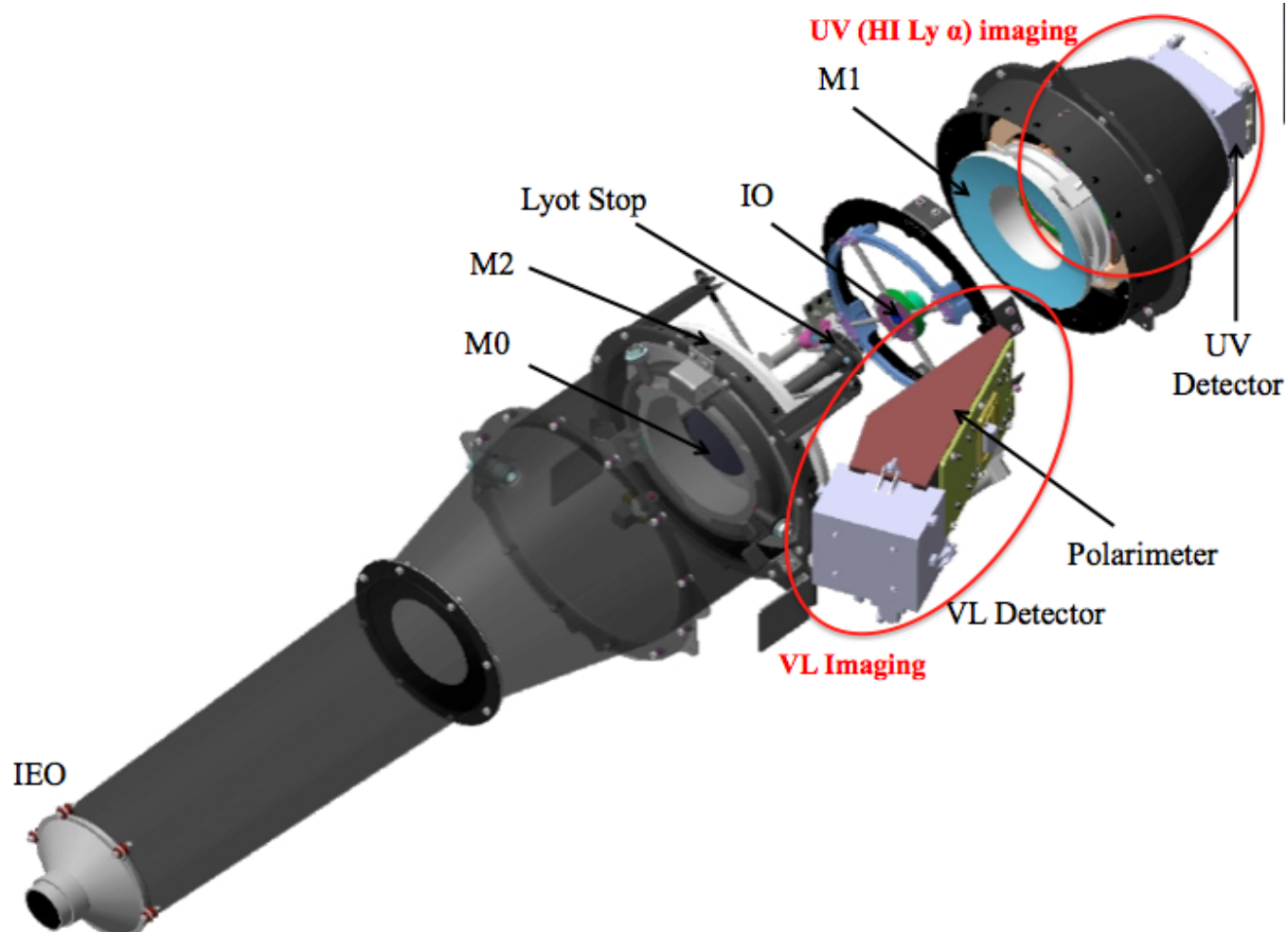

# Metis Subsystems

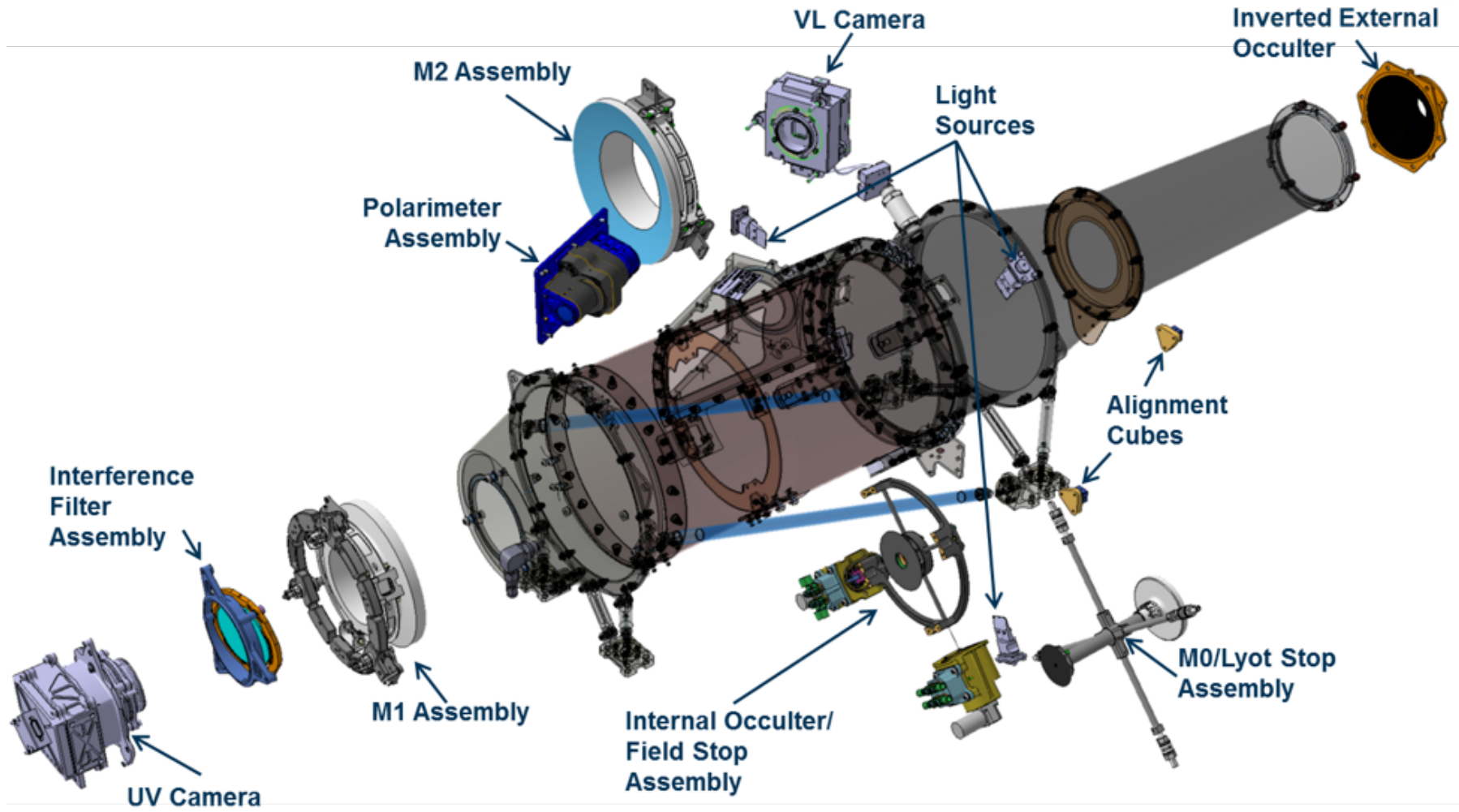

- MOU** METIS Optical Unit
- MPPU** METIS Power Processing Unit
- HVU** High Voltage Unit
- CPC** Camera Power Converter

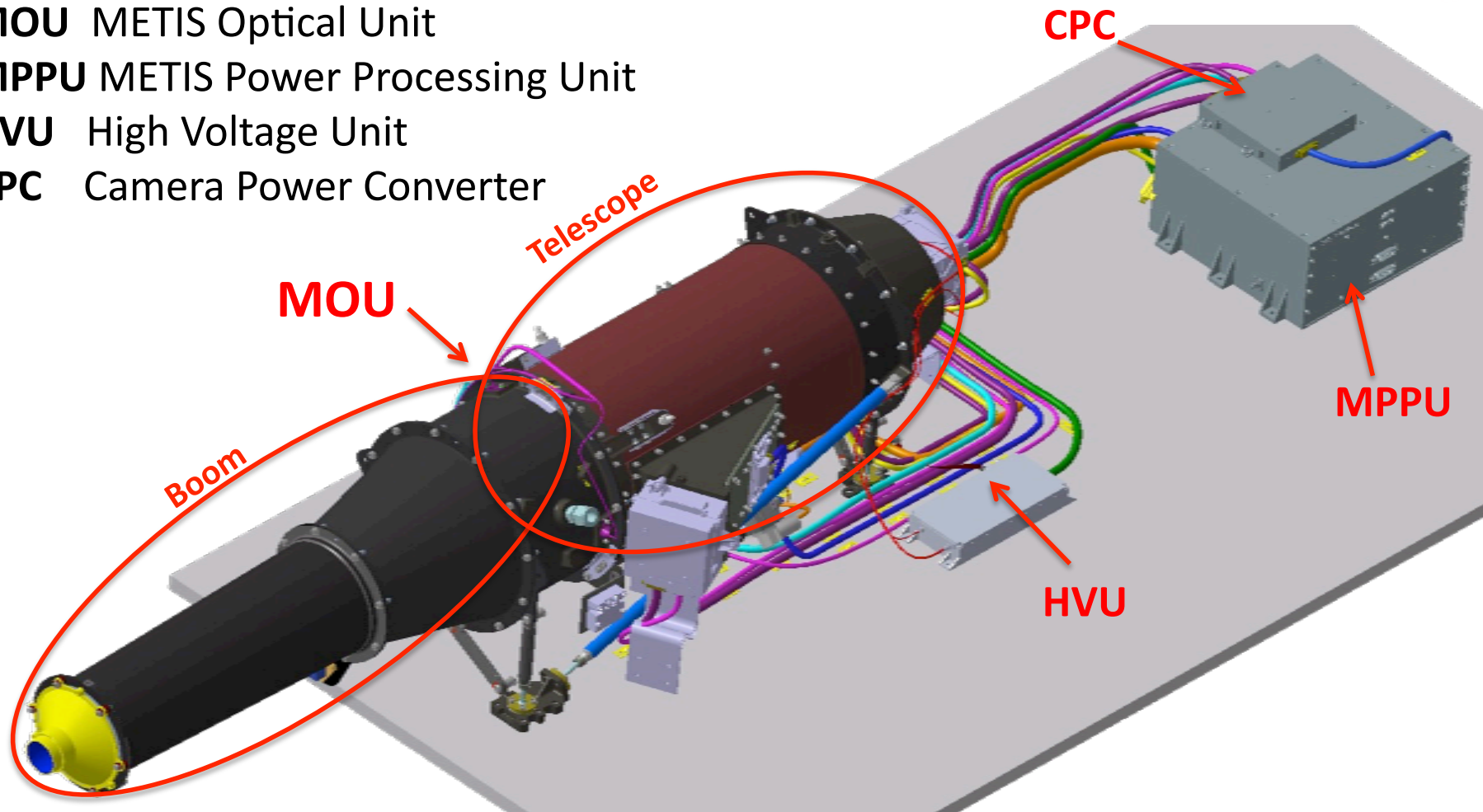

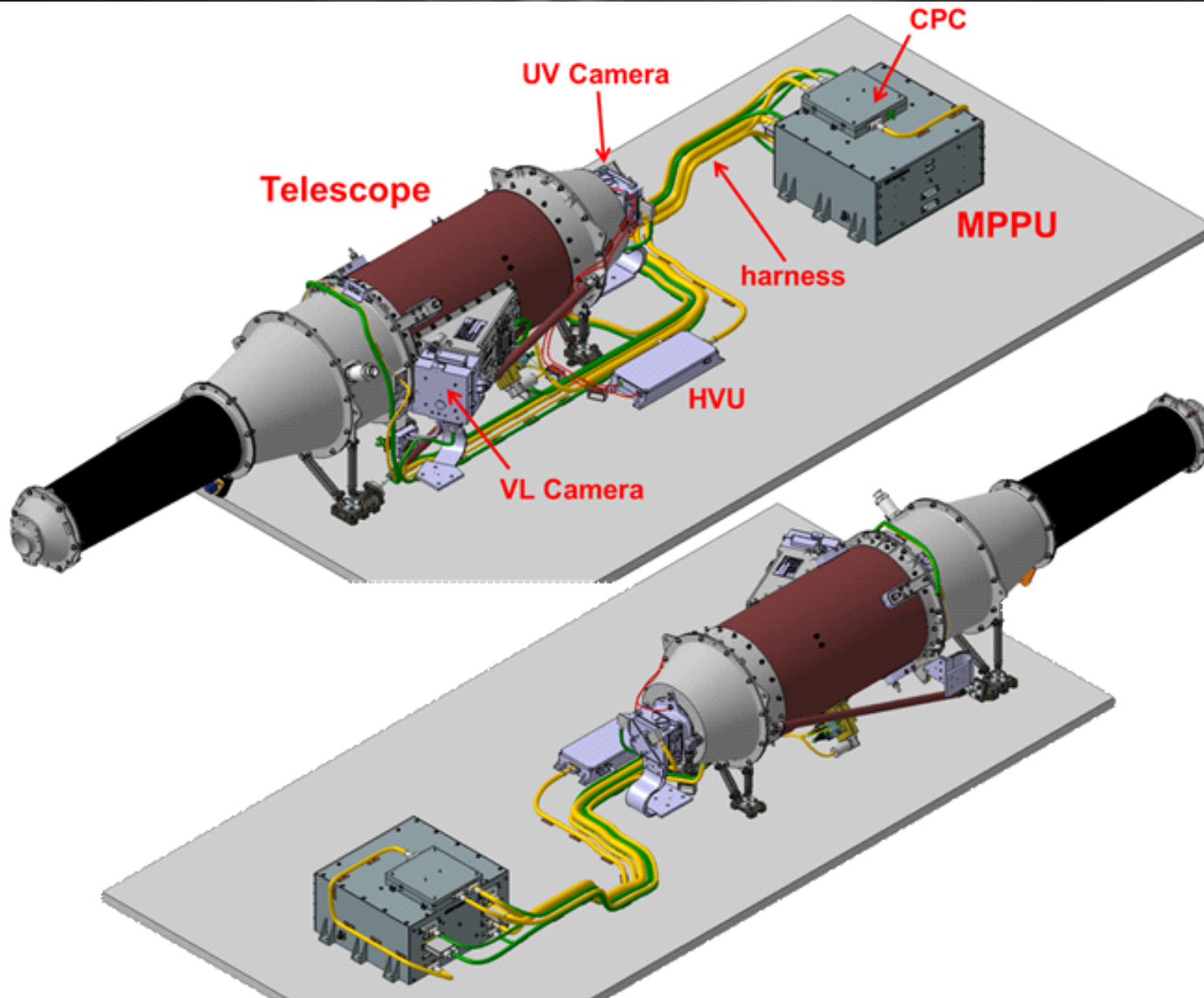

## ASI-INAF instrument

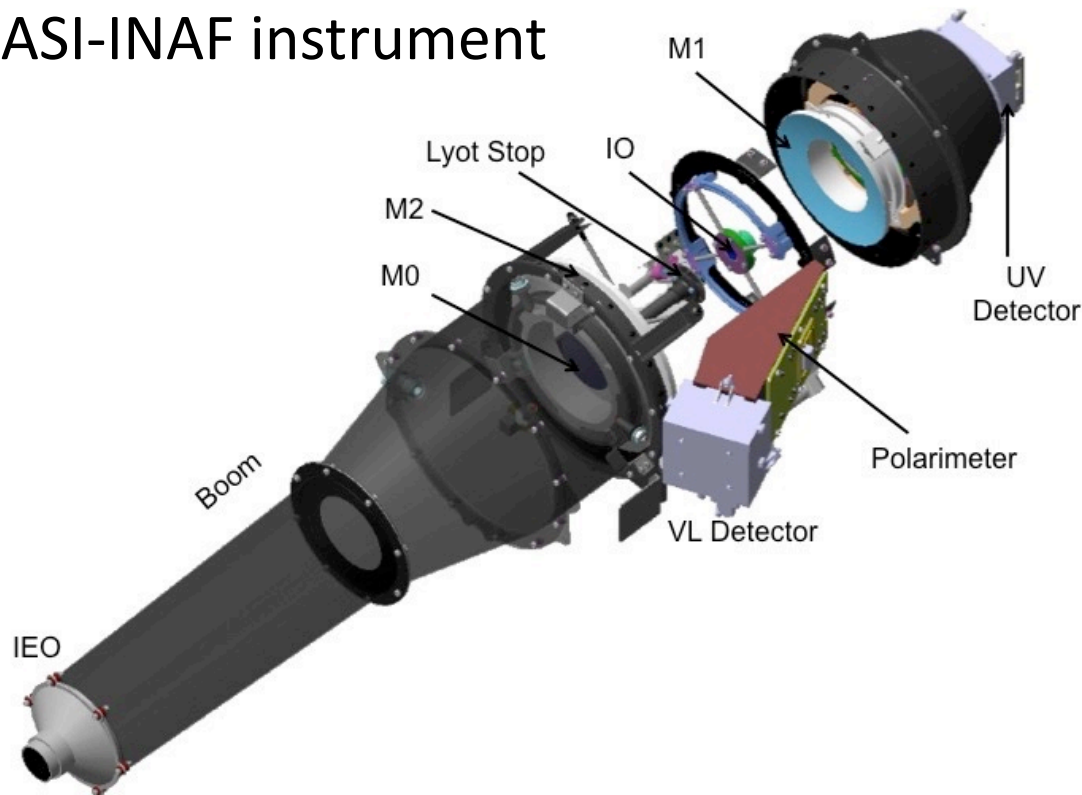

### Mirrors M1, M2

contribution of the Institute of Astronomy, Czech Academy of Science

**Metis Detection Subsystem**  
 contributed/implemented by Max Planck Institut für Sonnensystemforschung (MPS)

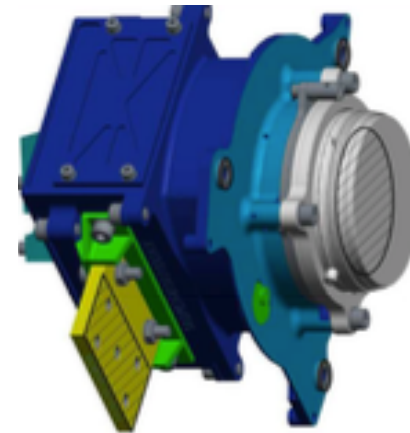

UVDA equipped with CMOS Active Pixel Sensor (1024 x 1024 pixels, 15x15  $\mu\text{m}^2$  size).

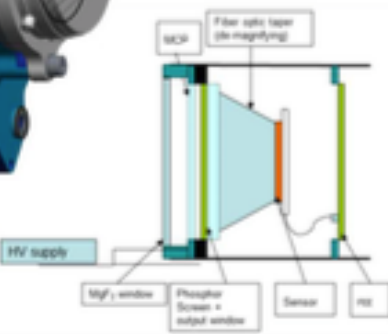
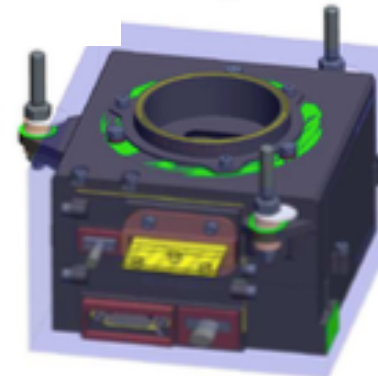

VLDA equipped with CMOS Active Pixel Sensor (2048 x 2048 pixels, 10 x 10  $\mu\text{m}^2$  size).

# Metis Instrument Integration



# Metis Integration on the Spacecraft





# Mission Profile

## Zooming along the Orbit

2017\_case2\_late.bsp

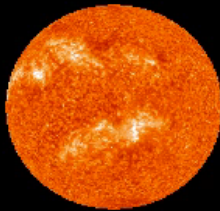

2017-01-24

Dist: 0.984  
Lon: 180.6  
Lat: -5.3

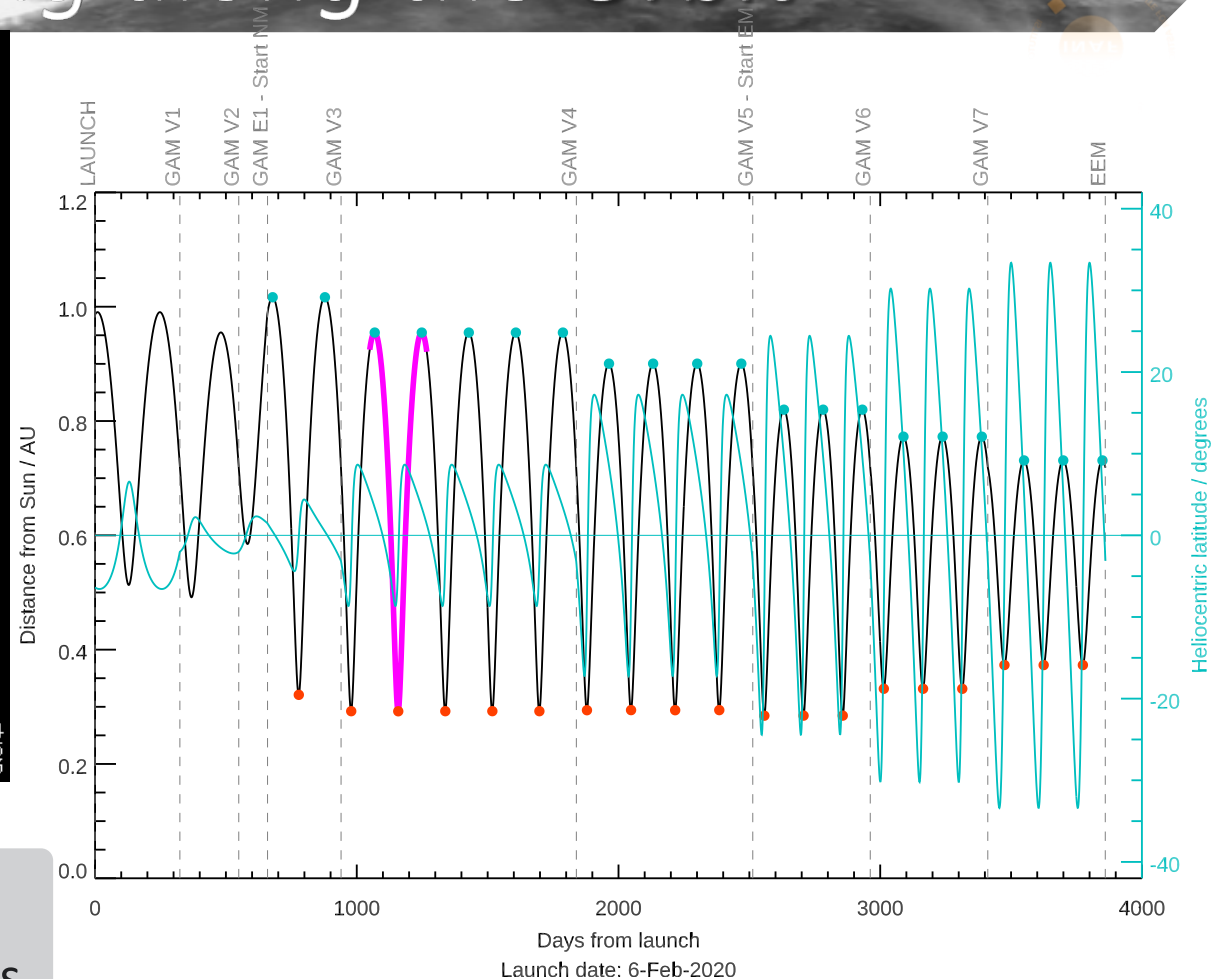

### Launch 7 Feb 2020

Cruise phase	1.8 years
Nominal mission phase	5 years
Extended phase	3.7 years

Minimum perihelion	0.28 AU
Maximum solar inclination	33.4°
Maximum angular rate	7.7 °/day
Orbital period	200-150 days

# Corona as viewed along the Orbit Low Latitudes

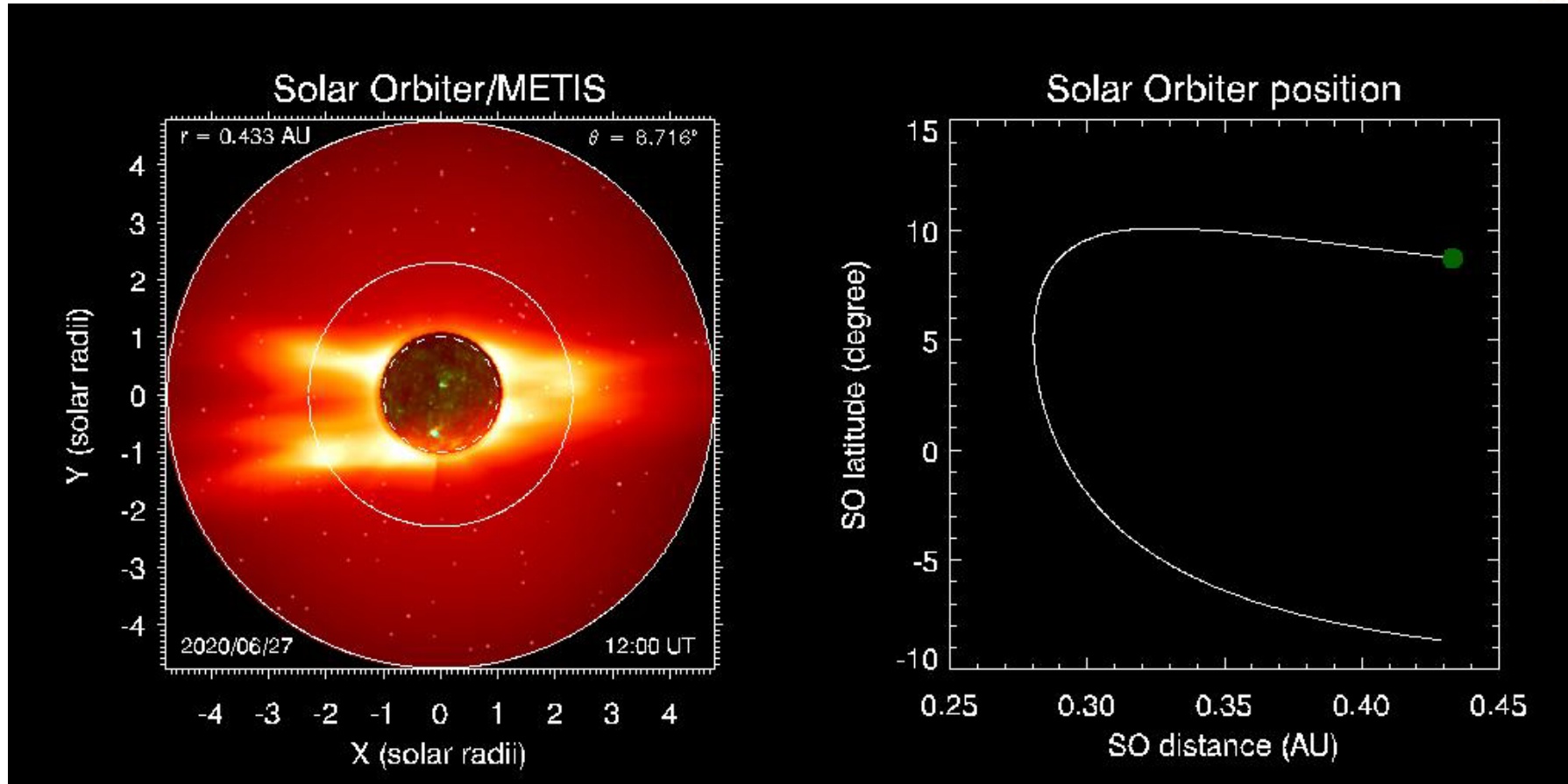

- LASCO/C2 and Mauna Loa/Mark IV coronal images during Carrington Rotation CR1931 (1997)  
→ construction of a 3D cube integrated step-by-step along the LOS depending on the spacecraft position
- EIT 195 A coronal images on disk
- Actual stars in the METIS field-of-view from Hipparcos star catalog

(Credit: A. Bemporad)

# Metis Variable Field of View within $1.7 - 9 R_{\odot}$

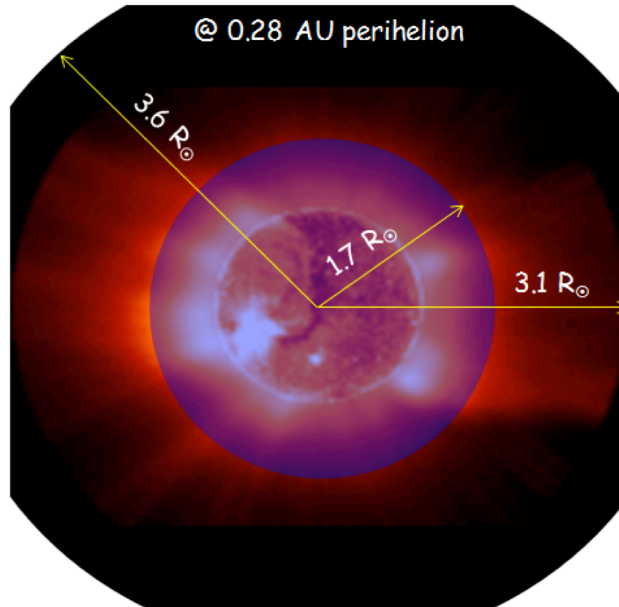

Variable FoV due to the orbit eccentricity

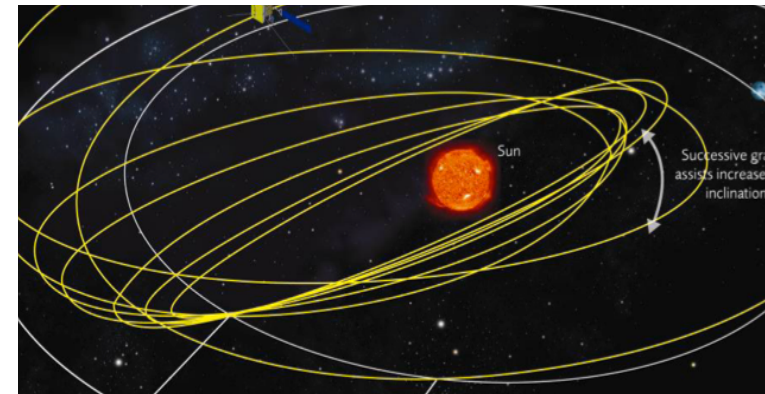

Perihelion at 0.28 AU  
FoV  $1.7-3.6 R_{\odot}$

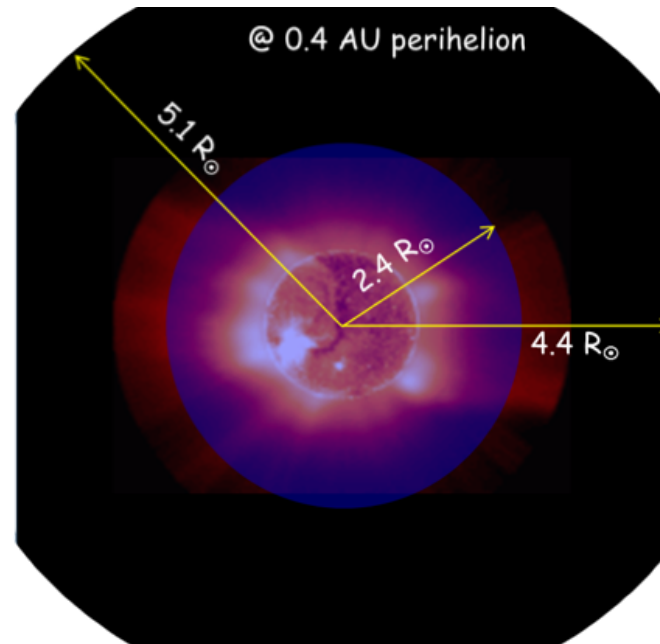

Perihelion at 0.4 AU  
 $2.4-5.1 R_{\odot}$

# FoV at 0.28 AU

## Metis Synthetic Images

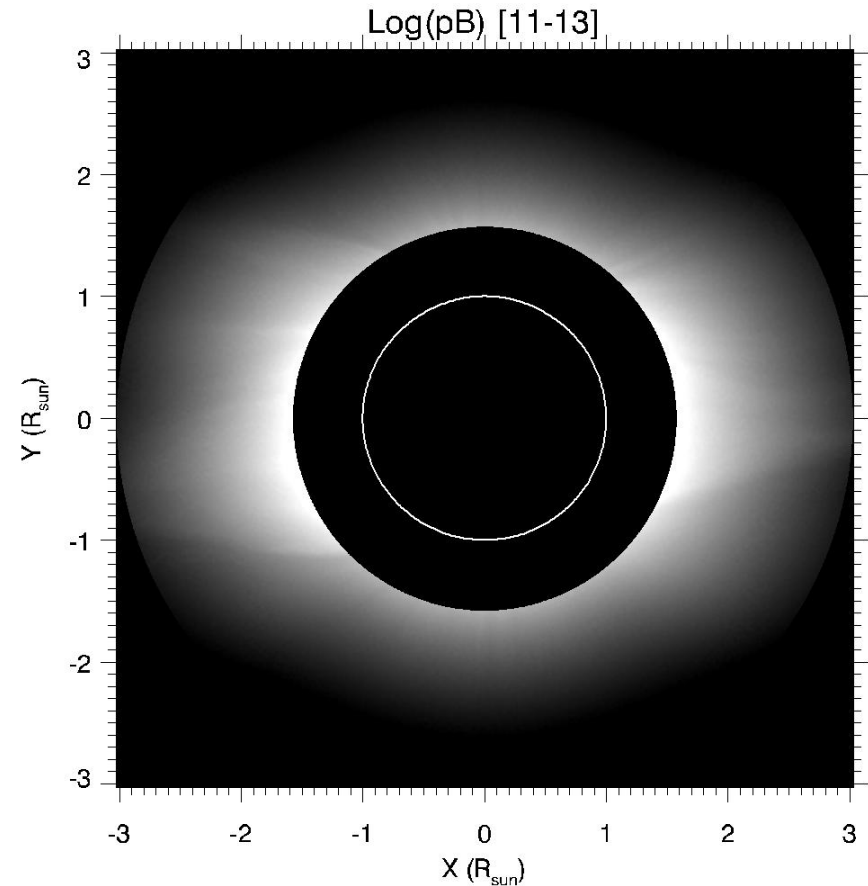
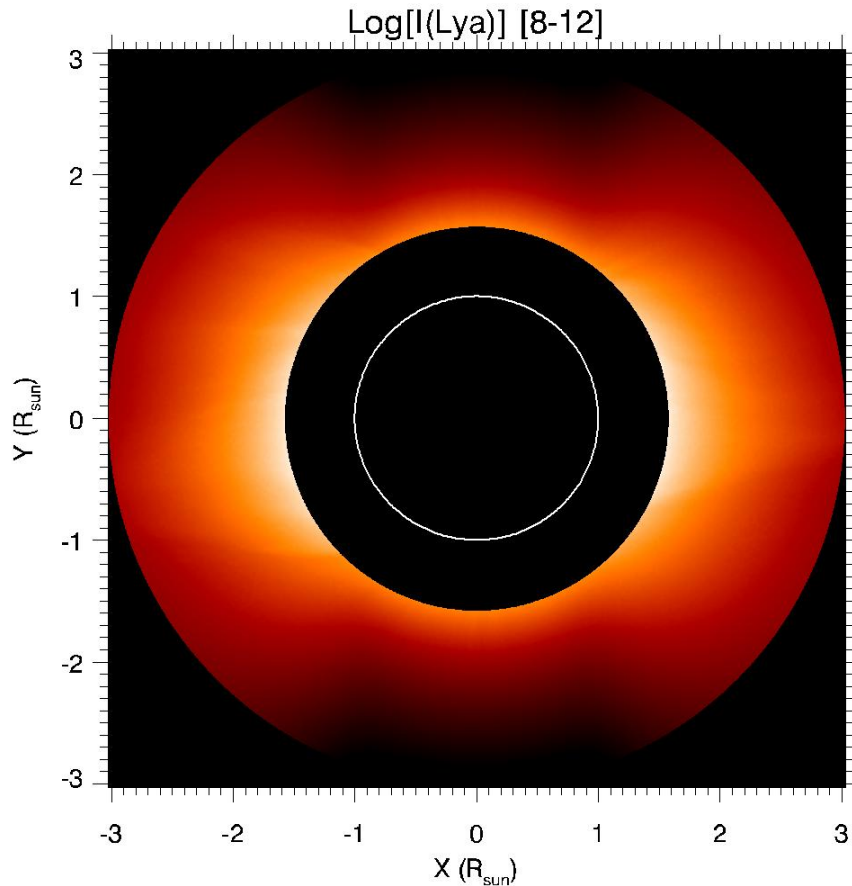

Expected Metis HI Ly $\alpha$  and polarized brightness images at 0.28 AU heliodistance, obtained on the basis of typical coronal parameters (static corona assumption)

# *FoV at 0.50 AU*

## *Metis Synthetic Images*

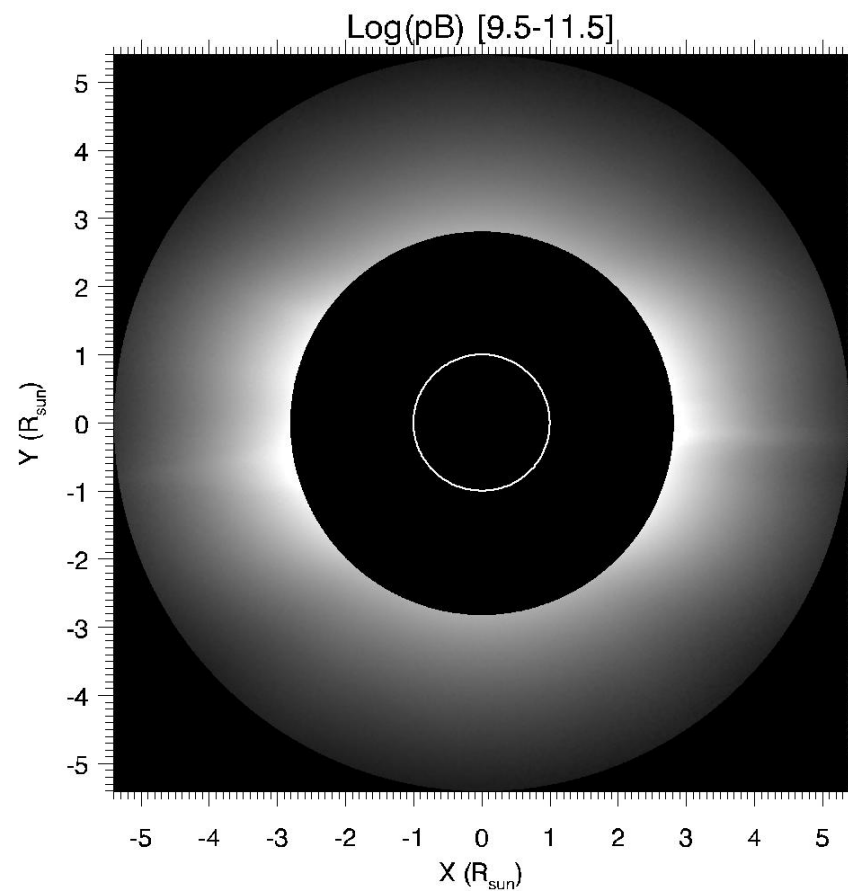
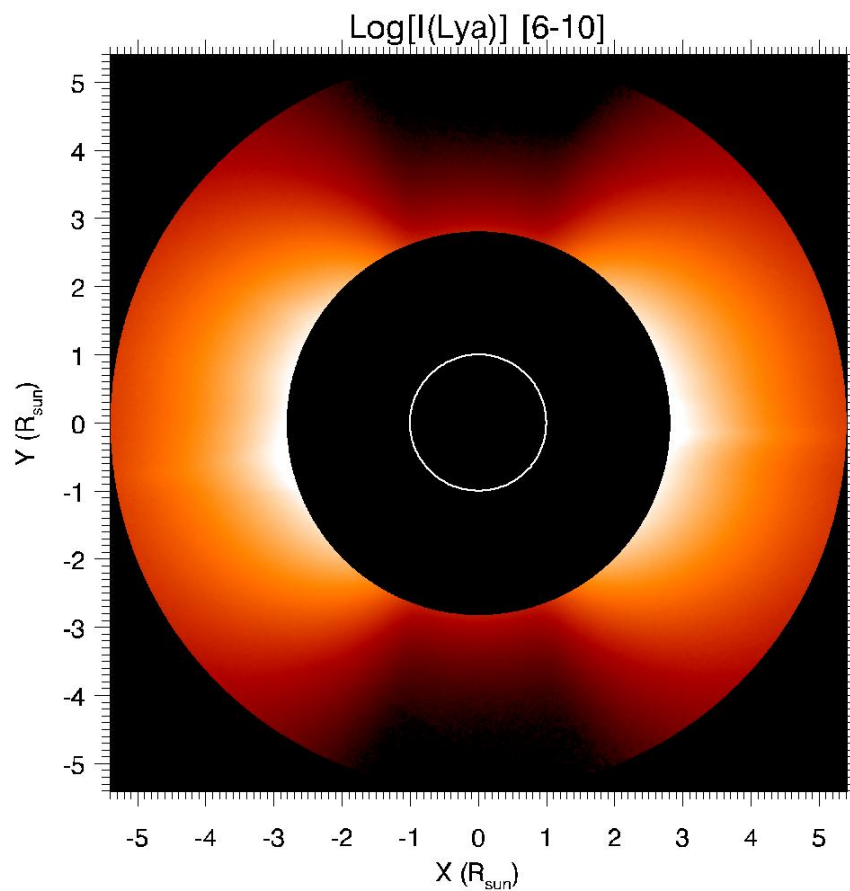

# Expected Coronal Outflow Maps

UV HI Ly $\alpha$  image derived from  
UVCS –SOHO observations

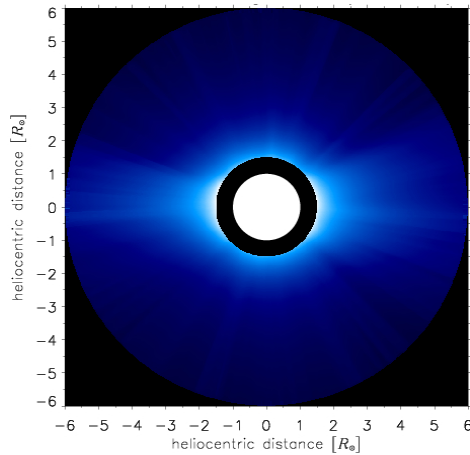

UV HI Ly $\alpha$  synthesized image  
of a *static corona* using Pb  
data obtained with LASCO-  
SOHO images

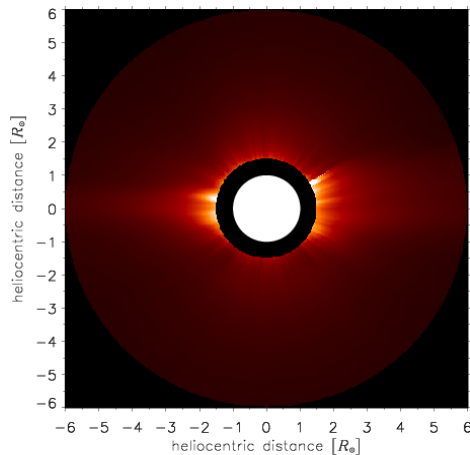

Derived 2D map on the plane of the sky  
of the speed of coronal plasma outflows

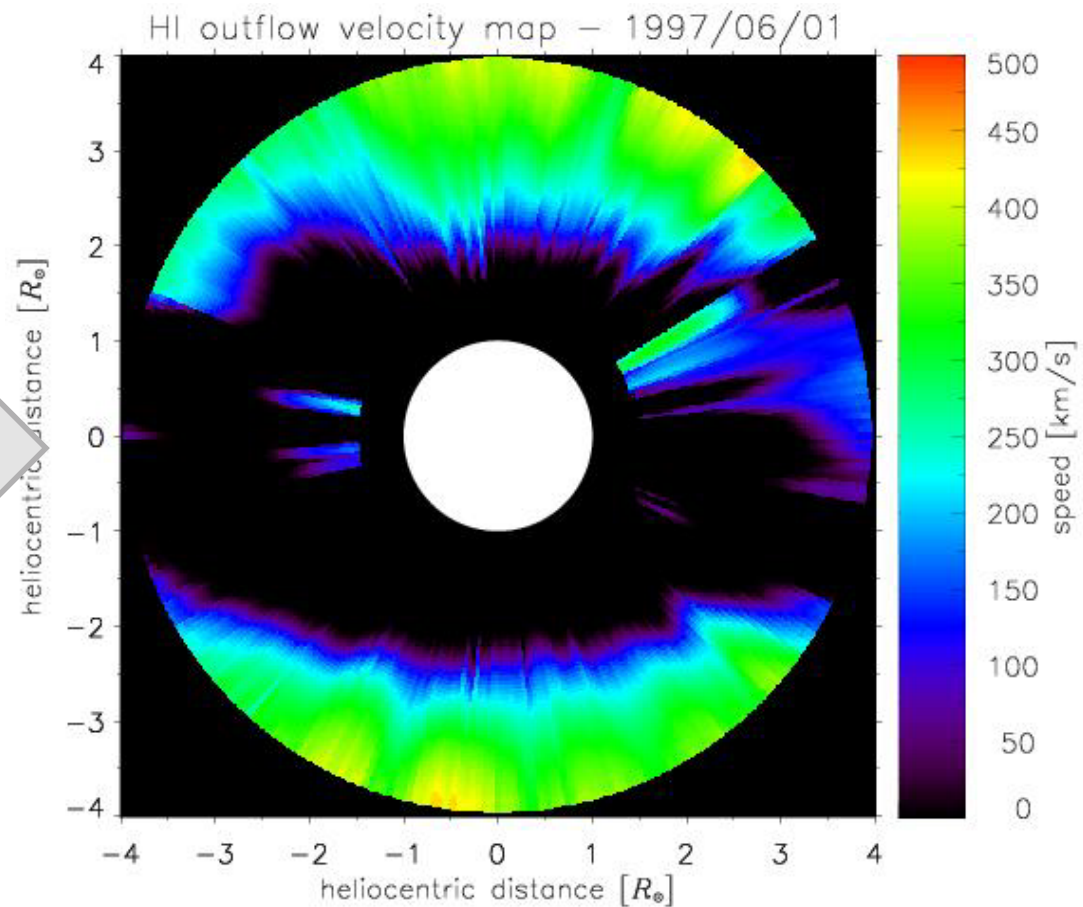

(Dolei et al. 2017)

# UV HI Ly $\alpha$ Synthesized Images Parameters

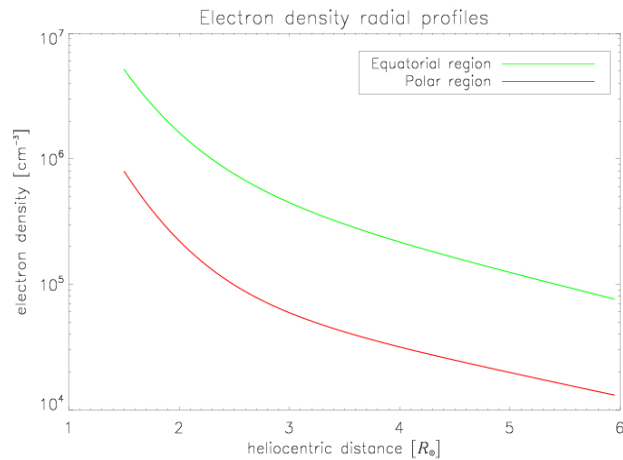

**Coronal  $n_e$**  from Van De Hulst inversion of the polarized VL images (PB images)

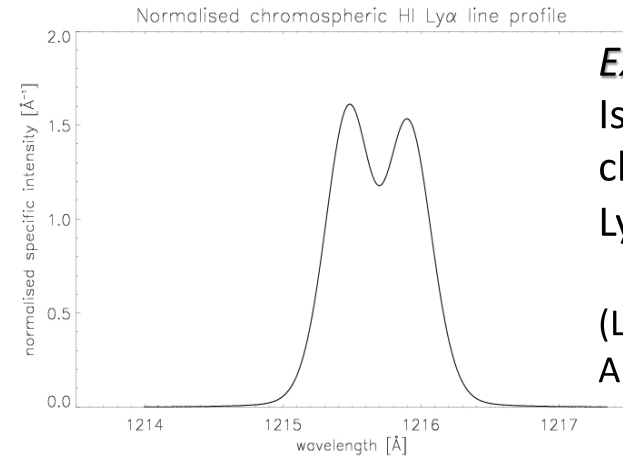

**Exciting photons**  
Isotropic chromospheric HI Ly $\alpha$  line profile

(Lemaire et al. 2002; Auchère 2005)

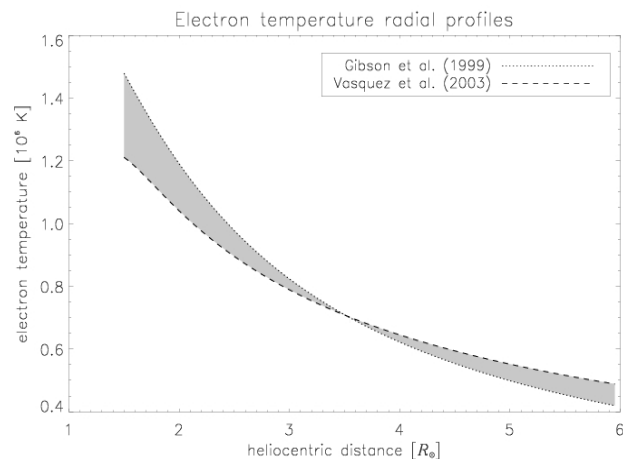

**Coronal  $T_e$**  radial profiles from interpolation of known profiles for equatorial streamers and polar coronal holes

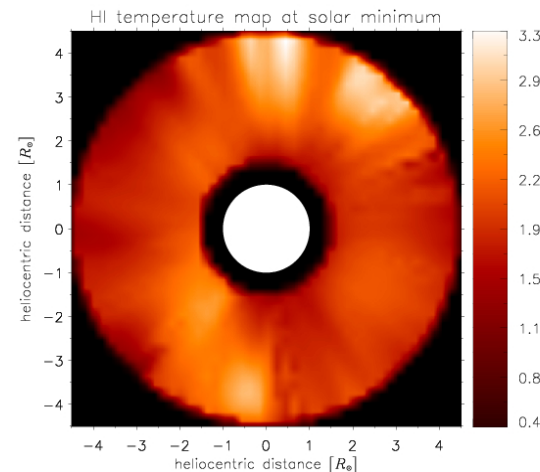

**Kinetic temperature** map of coronal HI atoms from UVCS Ly $\alpha$  observations at solar minimum

(Dolei et al. 2017)

# Solar Wind Outflows @ $2.5 R_{\odot}$ Neutral Hydrogen/Proton Component

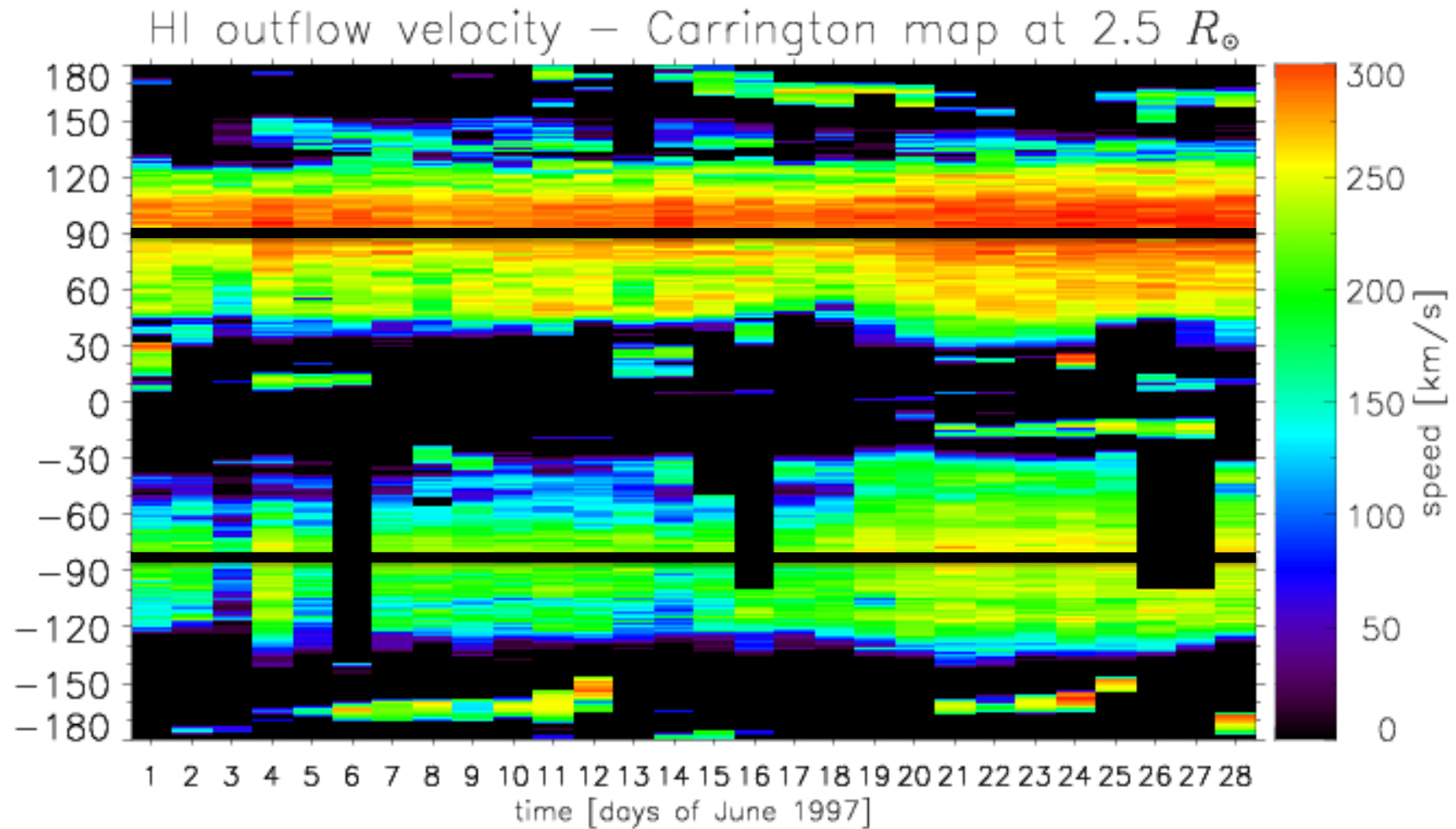

(Dolei et al, 2017)



# Solar Wind Outflows @ $3.5 R_{\odot}$ Neutral Hydrogen/Proton Component

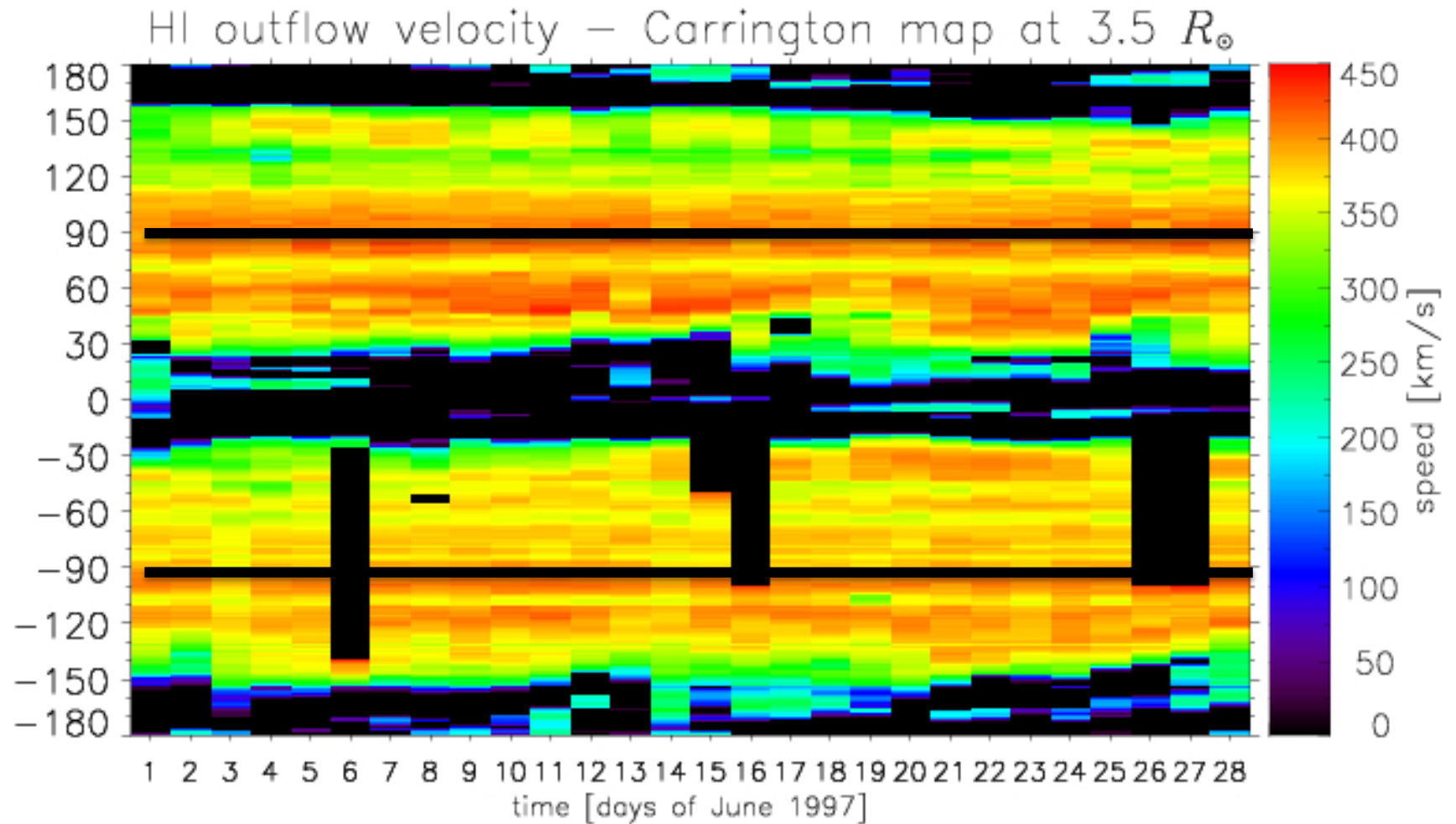

(Dolei et al, 2017)

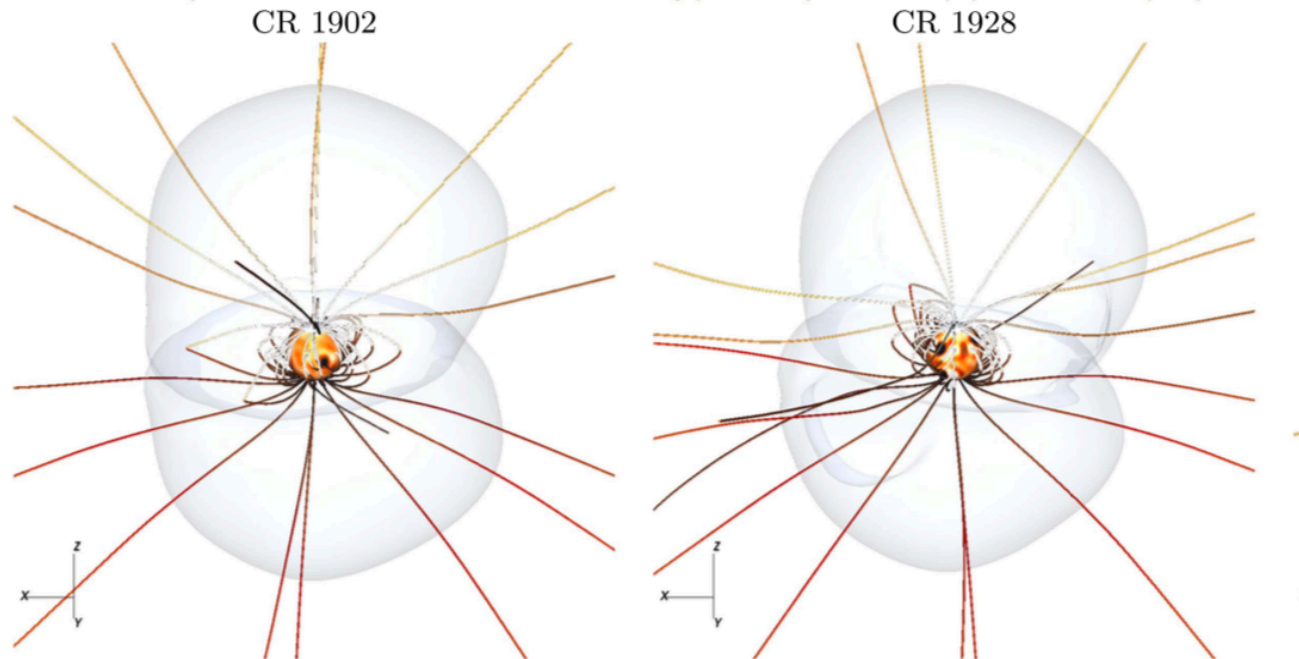

MHD solutions of the solar wind using WSO maps

identification of the Alfvén surface

CR 1902/1928 - Carrington rotations initiating on 27 Oct 1995 and 5 Oct 1997,  
respectively, minimum phase cycle 22

(Reville and Brun, 2017)

# Cycle 24 Sunspot Number (V2.0) Prediction (2016/10)

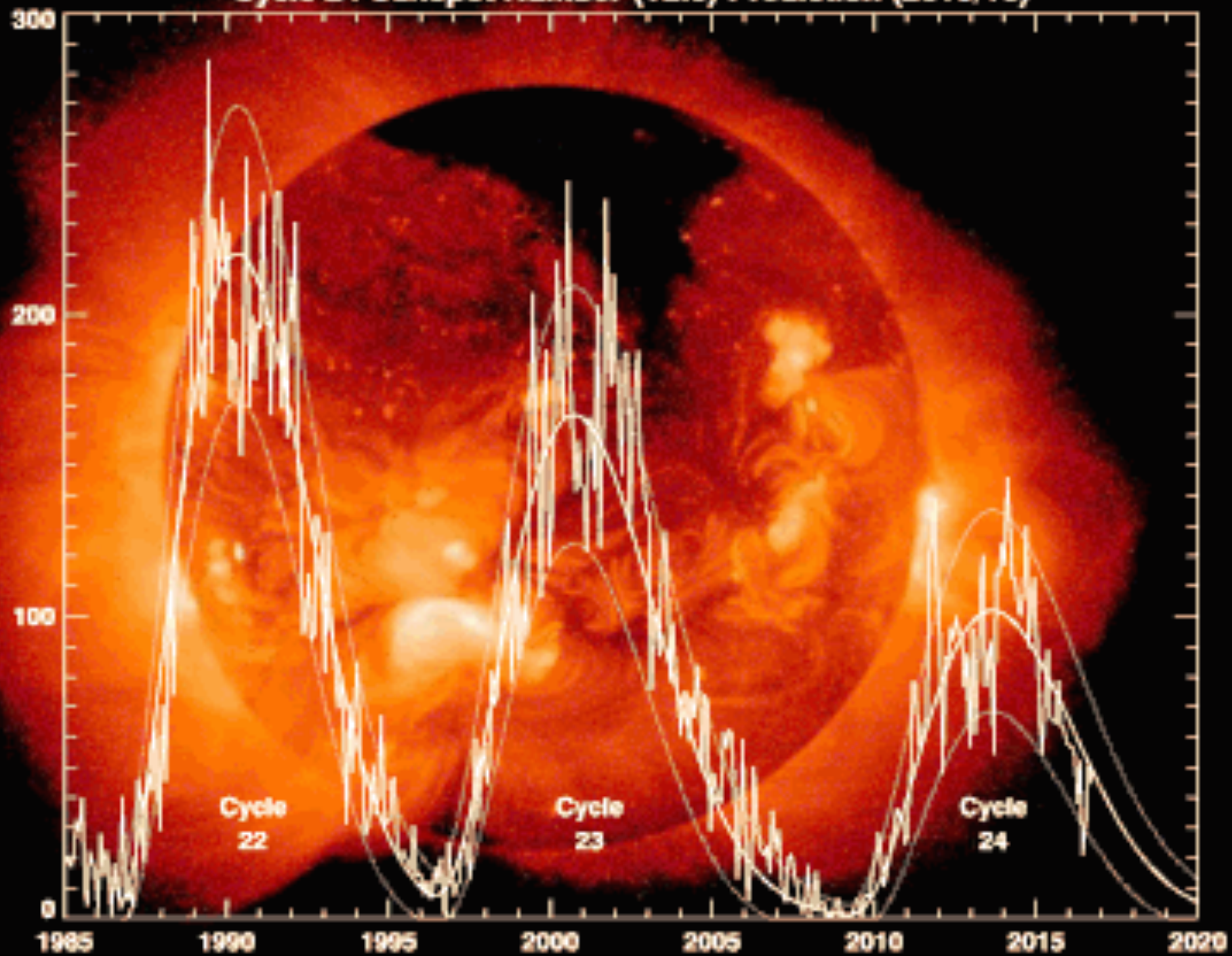

Hathaway NASA/ARC

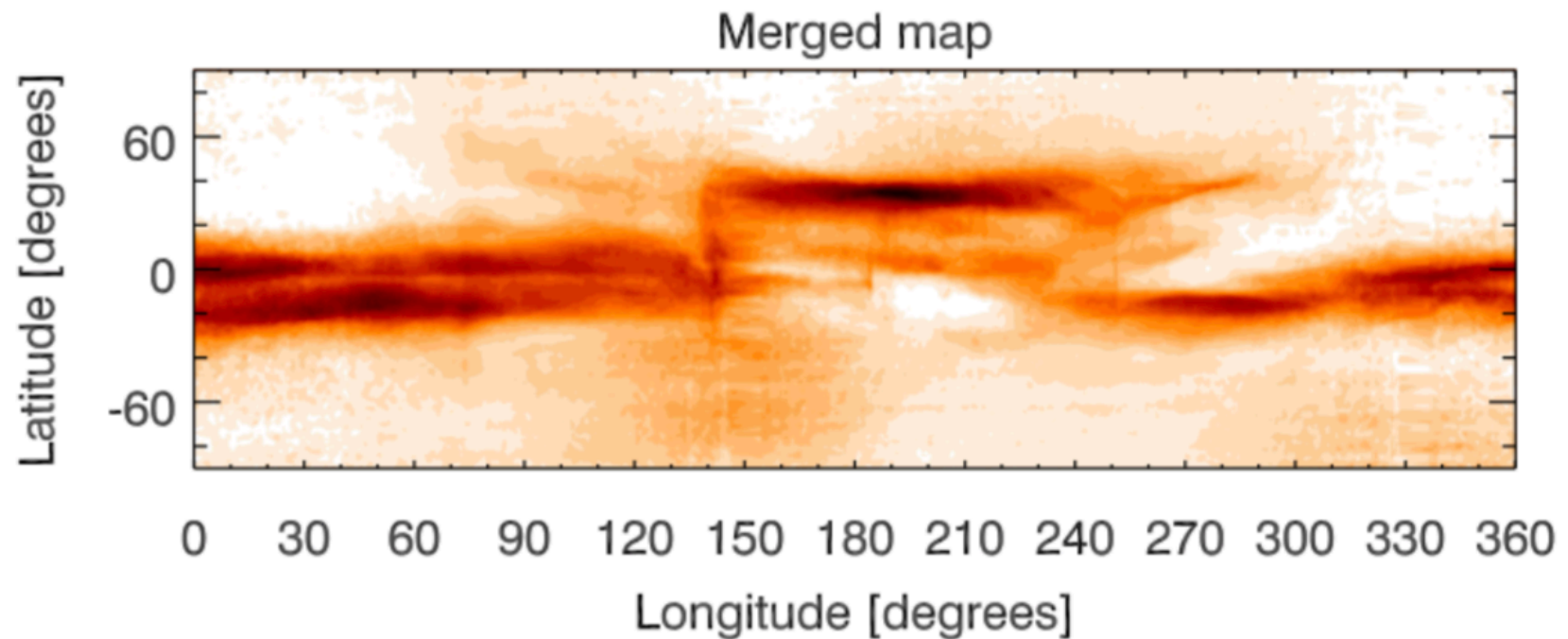

*Carrington map CR 2091 - Dec 07, 2009 - Jan 03 2010, minimum cycle 23 - rising phase solar cycle 24*

STEREO-B + SOHO + STEREO-A combined data  
minimum temporal evolution of the corona (4.5 days) in the observation  
from the different spacecraft

(C. Sasso et al., 2019)

Merged map

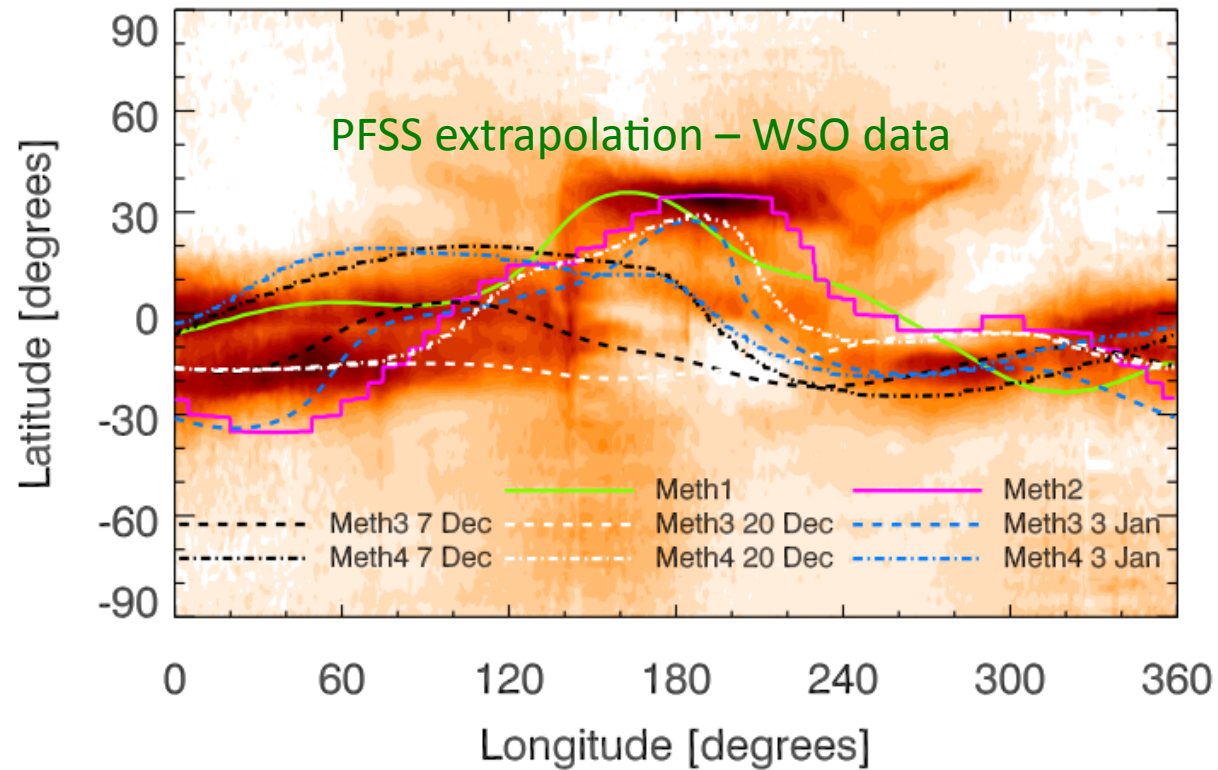

Visible light coronal map (STEREO-B + SOHO + STEREO-A) and superposed magnetic field neutral line obtained with different extrapolation methods: 1) – PFSS extrapolation WSO data; 2) - PFSS extrapolation WSO data with polar field correction (PFSS Potential Field Source Surface)

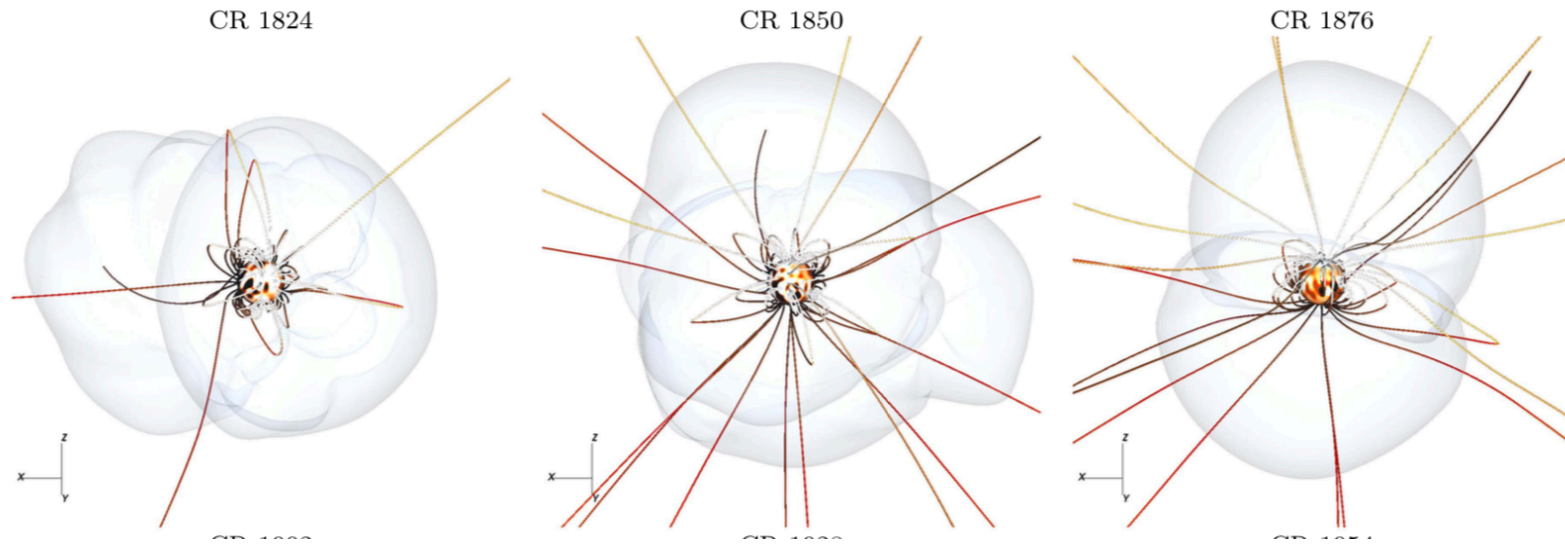

MHD solutions of the solar wind using WSO maps  
identification of the Alfvén surface

CR 1824/1850/1876 - Carrington rotations initiating on 28 Dec 1991, 8 Dec 1991  
and 17 Nov 1993, respectively, maximum and descending phases of cycle 22

(Reville and Brun, 2017)

# Solar Wind in the 3D Heliosphere

## 2 Solar Cycles

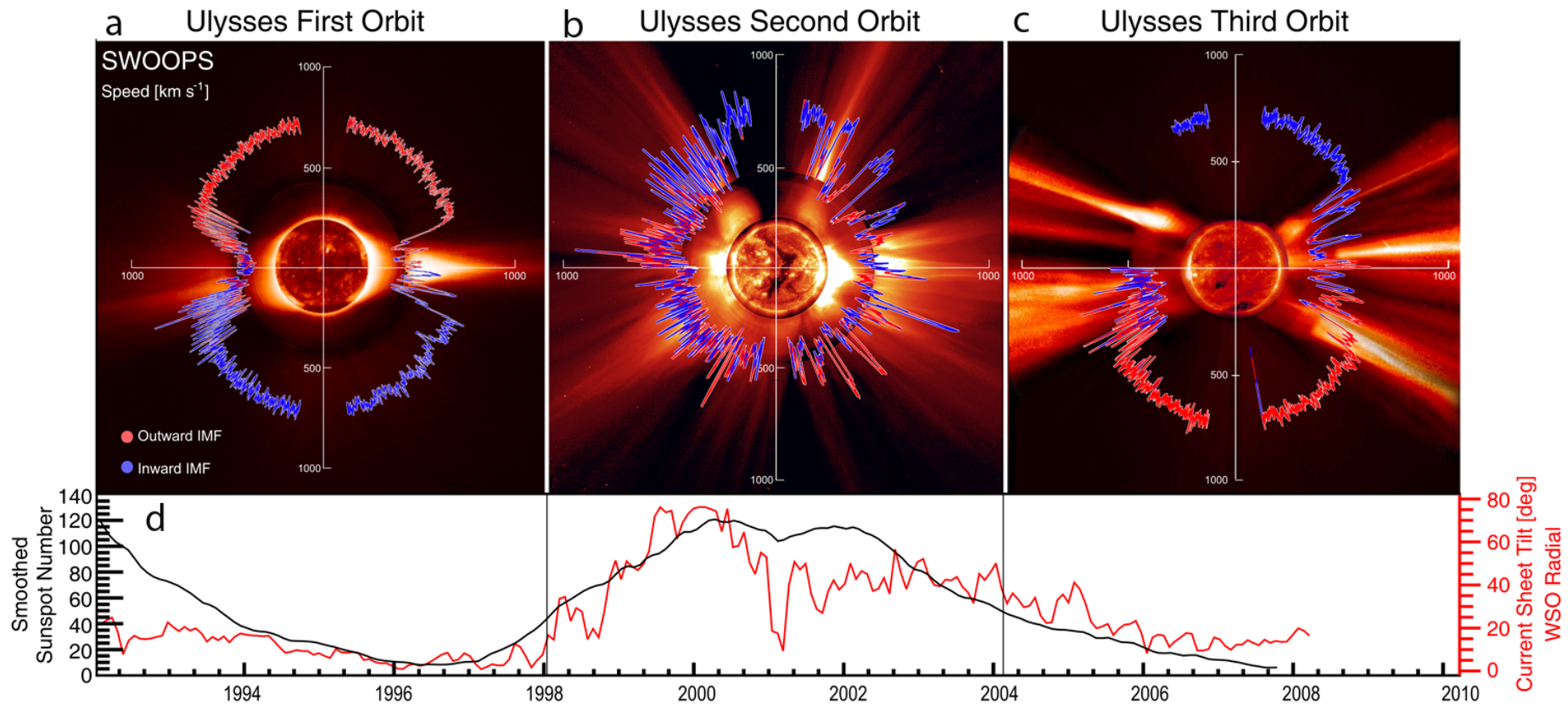

## *CME in Ly $\alpha$ emission*

- dynamics of the ambient corona (coronal wind) affecting CME propagation in corona
- determining the heliospheric wind pattern affecting CME propagation in heliosphere

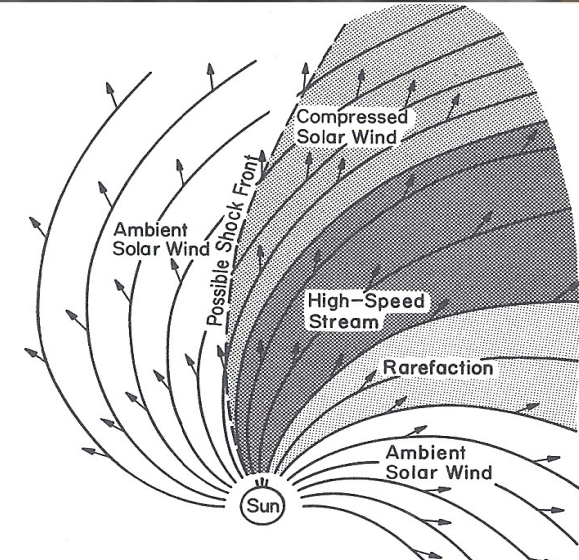

A. J. Hundhausen, 1972

## *CME in polarized VL light*

- direction of propagation with different methods
- identification of the source on disk (extrapolated)
- information on dynamics & energetics of the ejected plasma

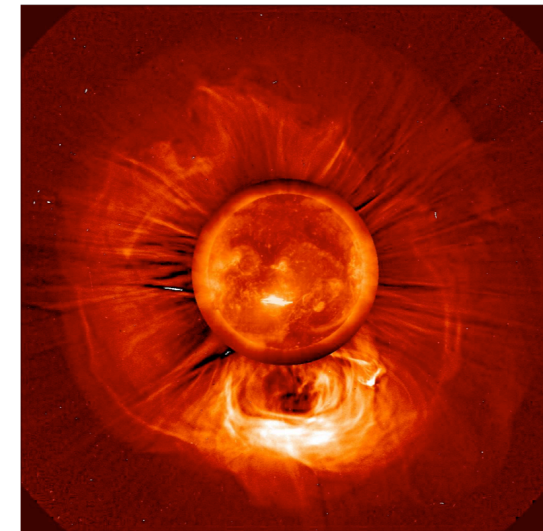



## CME propagation direction inferred from polarization ratio

degree of polarization of Thomson-scattering of photospheric light by coronal electrons depends on scattering angle (Billings 1966)

pB-tB images contain information on CME 3-D structure (e.g. Crifo et al. 1983, Moran & Davila 2004, Moran 2010)

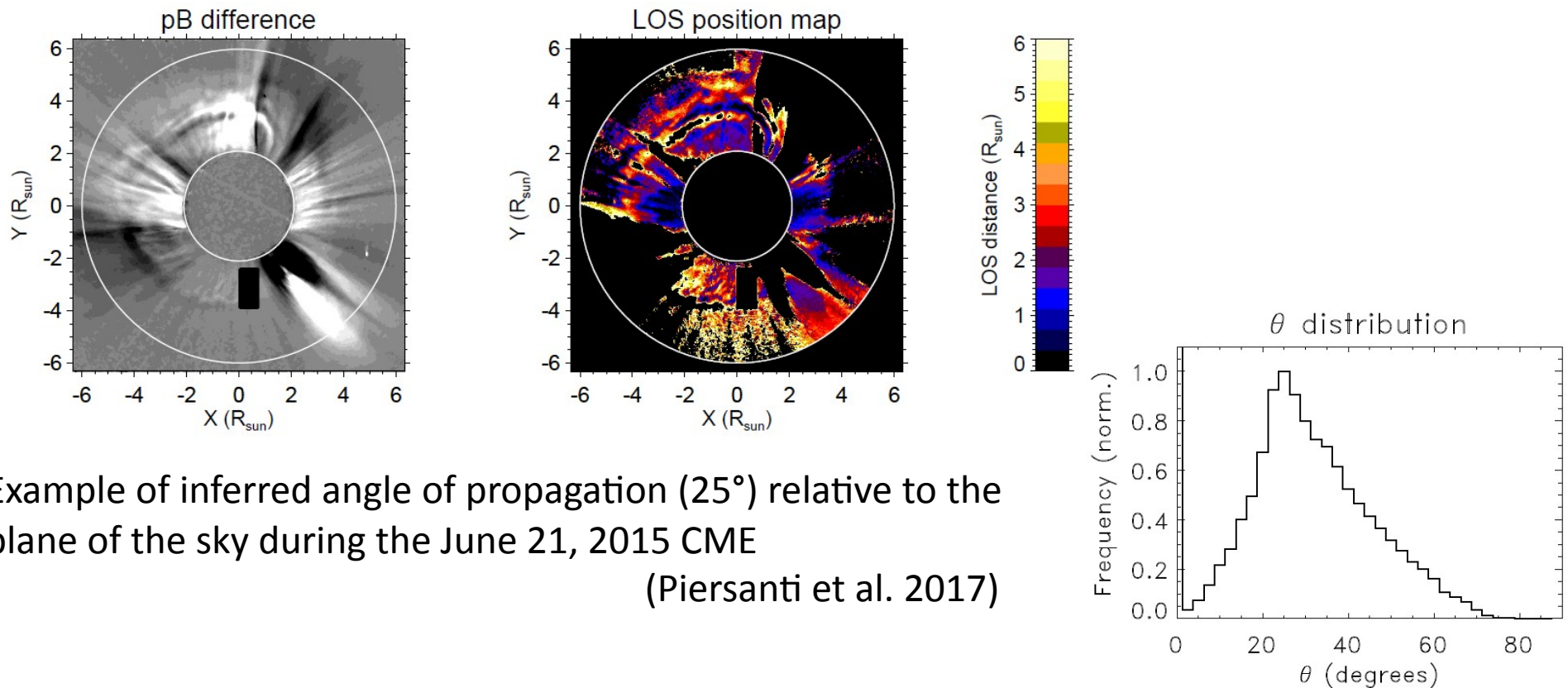

Example of inferred angle of propagation ( $25^\circ$ ) relative to the plane of the sky during the June 21, 2015 CME

(Piersanti et al. 2017)

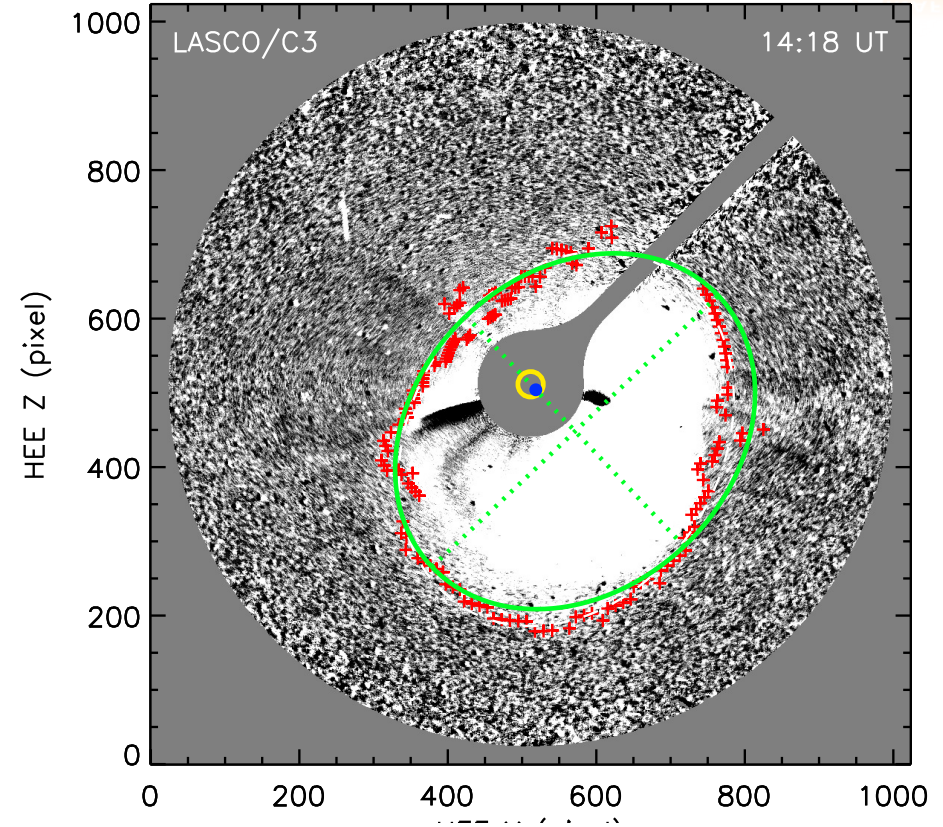
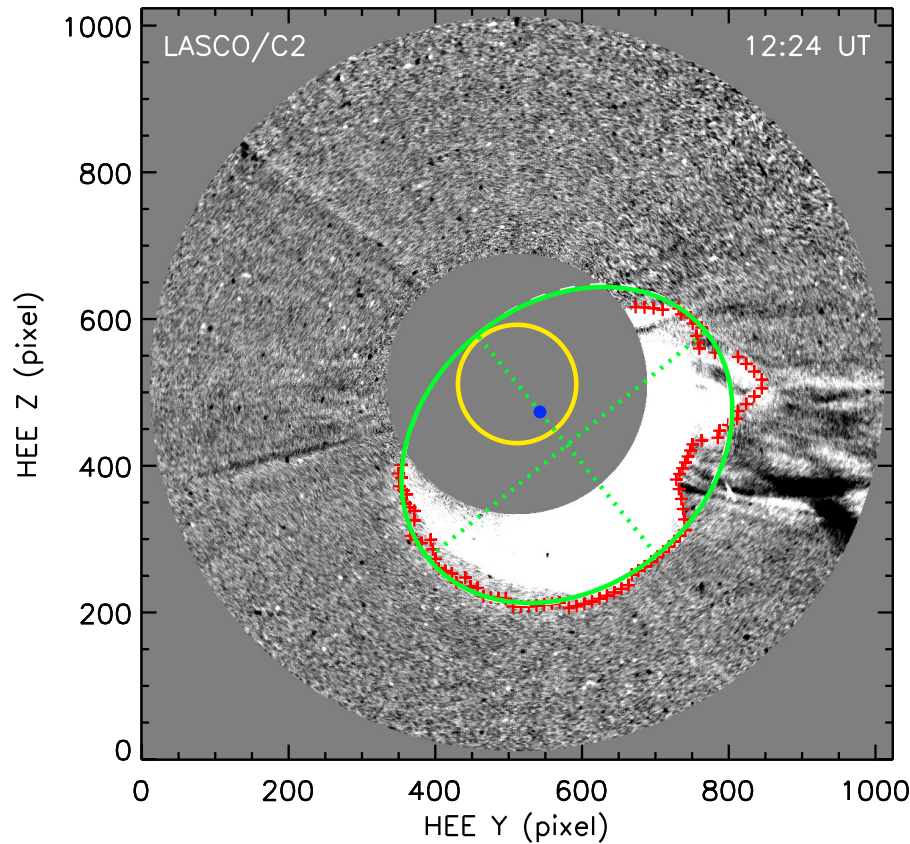

## *CME propagation direction and CME on disk*

edge of the CME front is identified in the map along each radial direction  
 points enveloping the CME front are fitted with an ellipsis  
 derived cone axis is projected back to the Sun's disk

(Susino et al. 2019)



# CME Sep 6, 2017

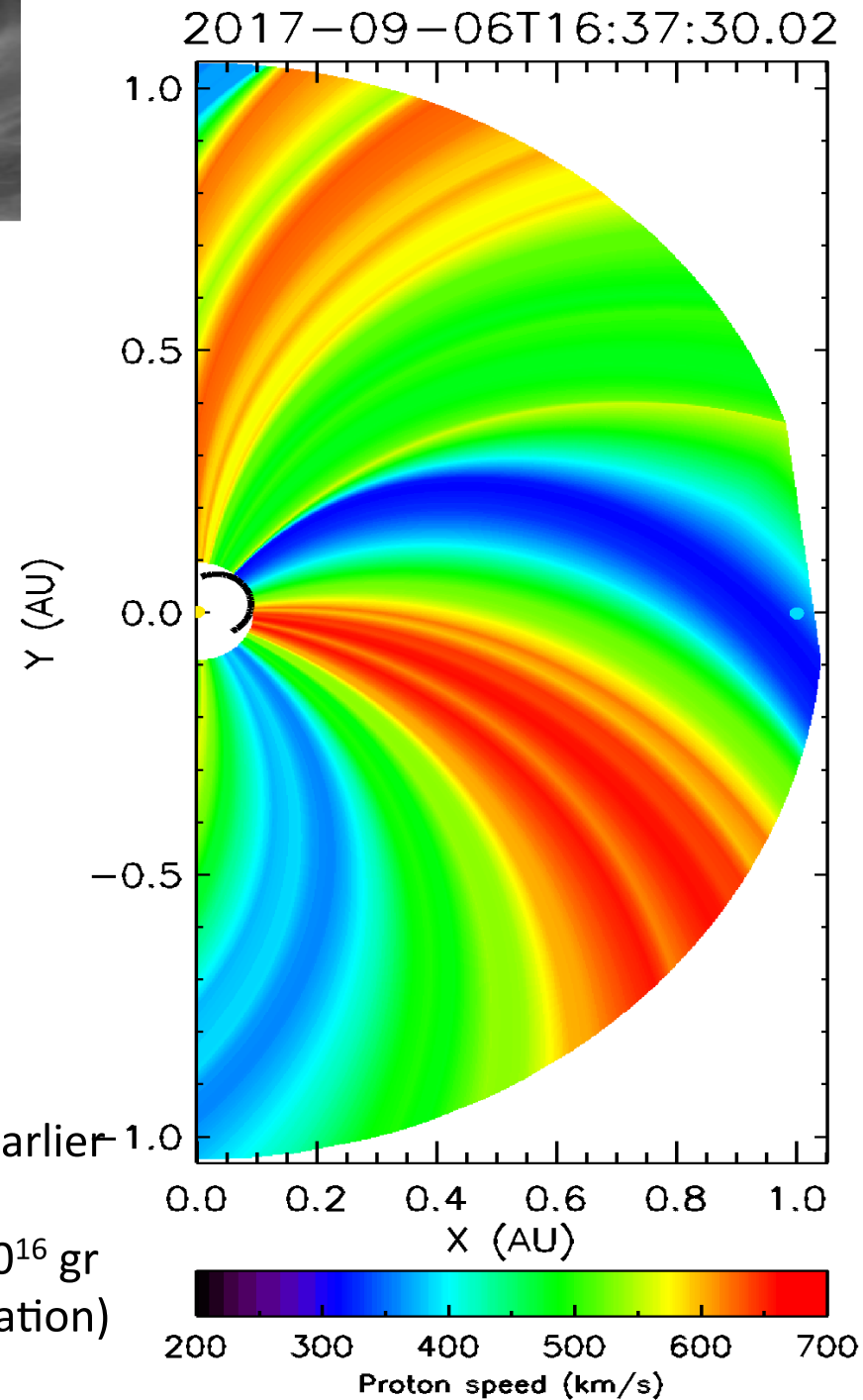
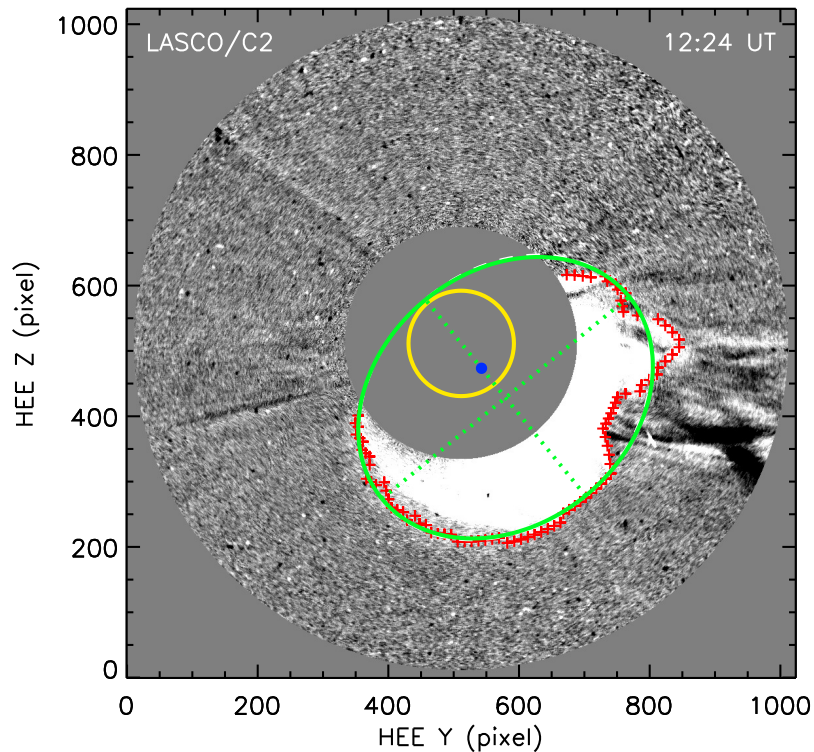

## *CME propagation in the solar wind*

Wind model using DSCVR & STEREO-A data 10 d earlier

Parker model

CME initial speed  $1300 \text{ km s}^{-1}$ ,  $120^\circ$  long. ext.,  $5 \cdot 10^{16} \text{ gr}$

(see R. Susino presentation)

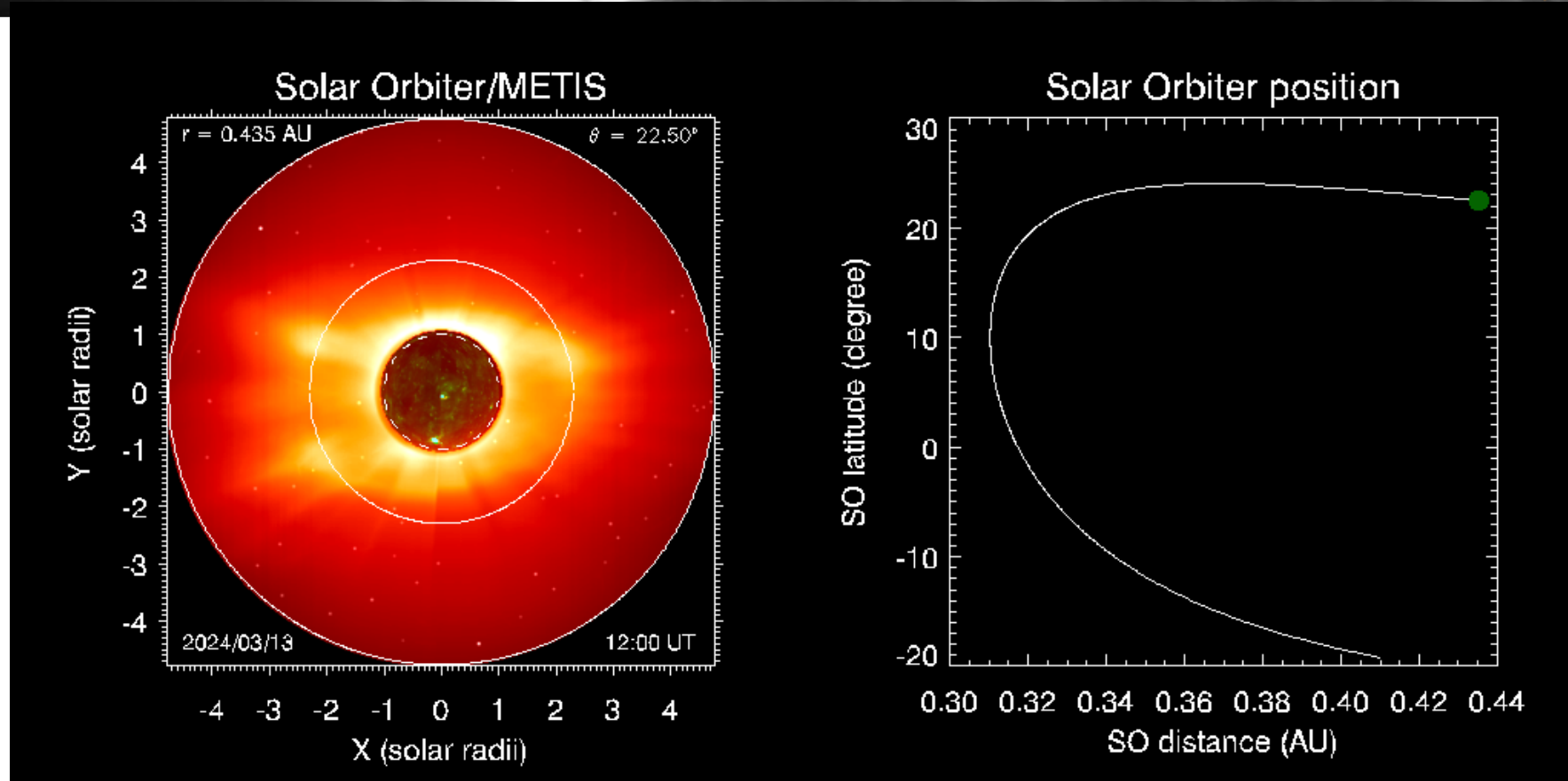

**Movie of METIS FOV evolution during 30 days period centered on the perihelium passage:**

- METIS «zooming» effect as SO approaches the Sun
- 3D rotation of the solar disk (*from EIT Carrington map*)
- 3D rotation of solar corona seen from different latitudes (*from LASCO+MaunaLoa MK IV images*)
- Decrease in the solar rotation speed as SO approaches the Sun
- Increase in the apparent speed of the stellar field as SO approaches the Sun (*Hipparcos catalog*)

(Credit: A. Bemporad)

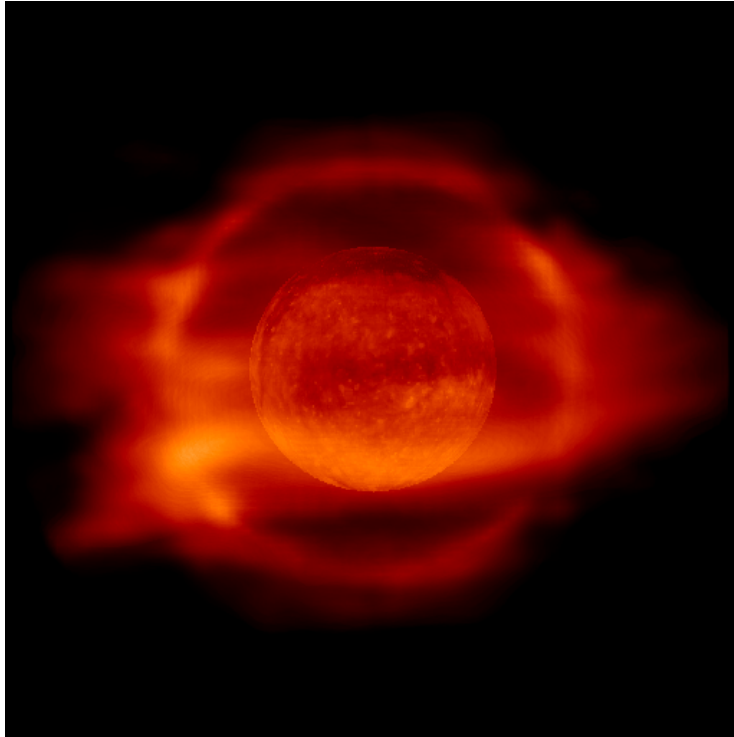

*View of the equatorial corona*

*Access to the longitudinal structure of the corona and longitudinal extent of coronal mass ejections.*

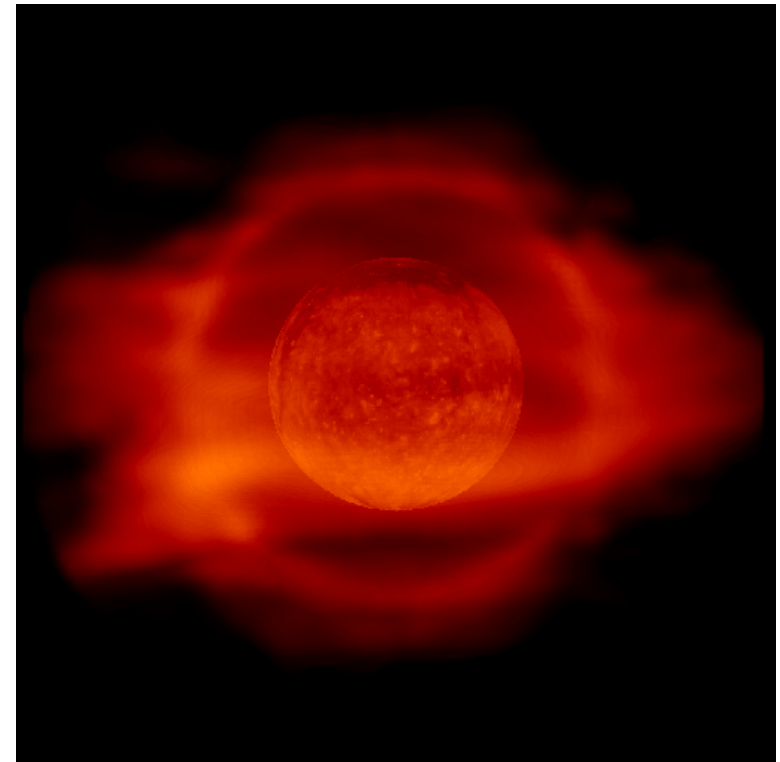

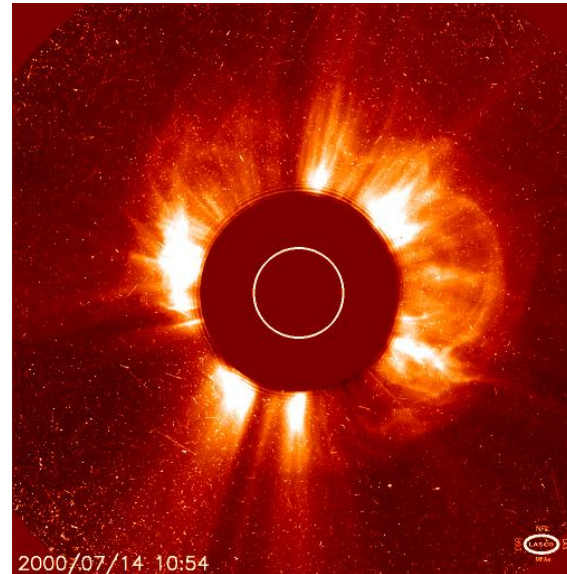
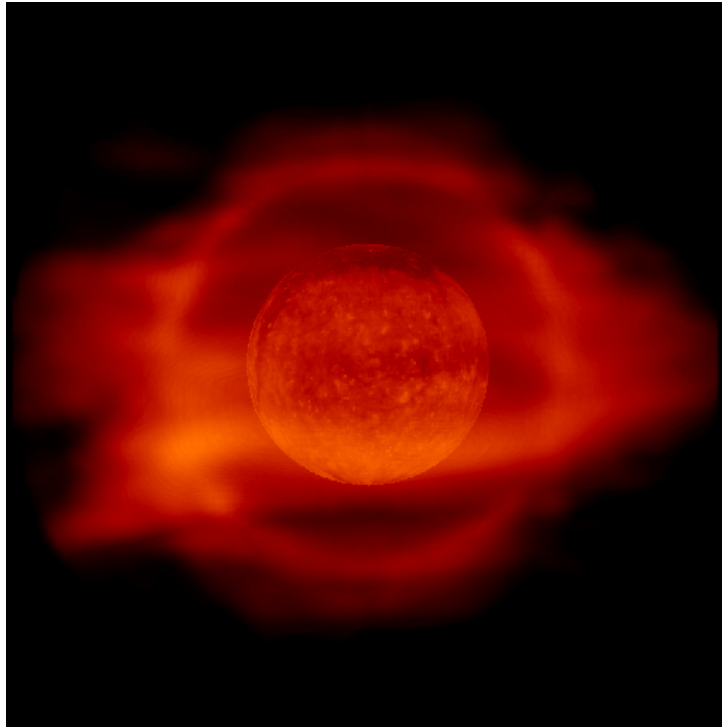

*Out of ecliptic ( $33^\circ$ ) observation of halo coronal mass ejections, impacting the Earth magnetosphere (geo-effective events)*

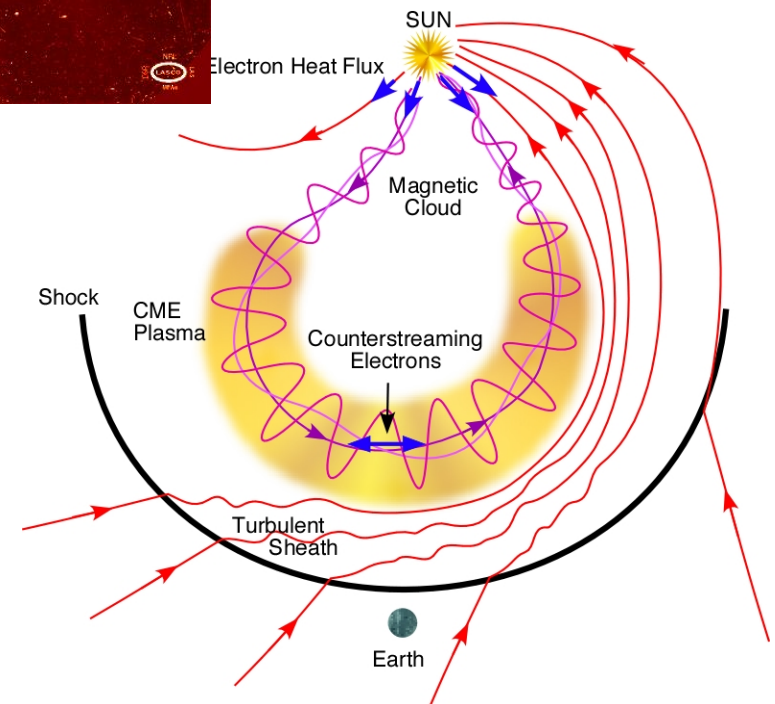

*L1*

*15°*

*30°*

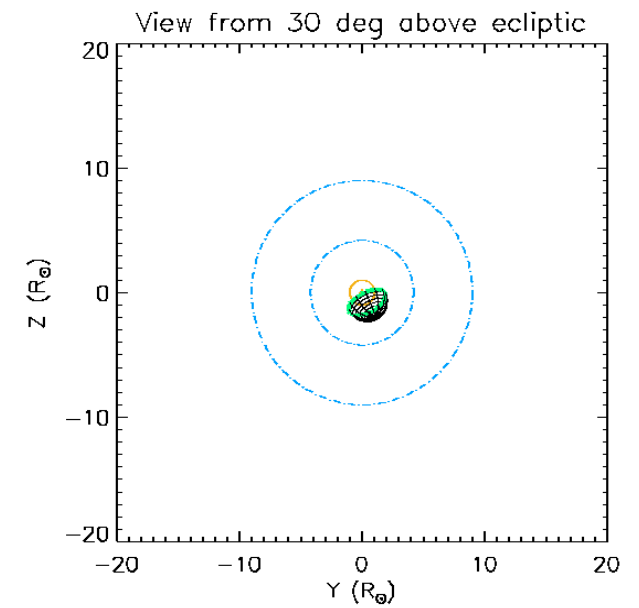
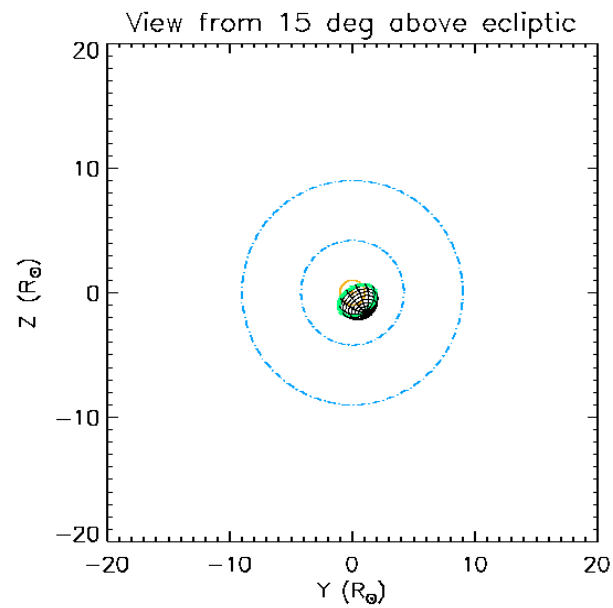
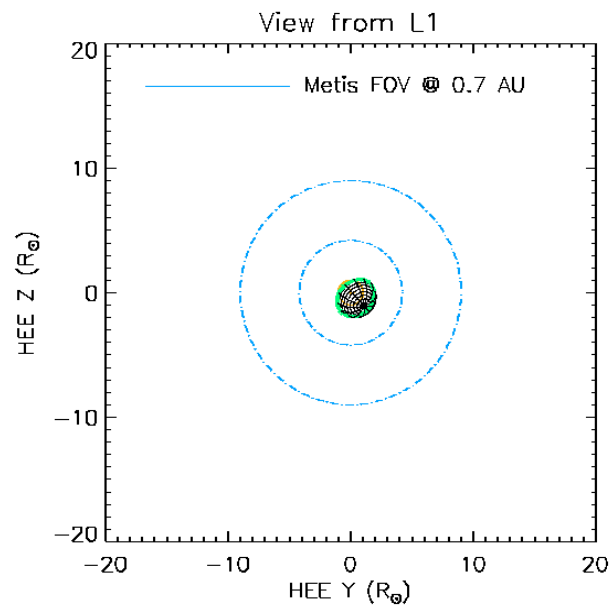

*Sep 6, 2017 CME  
cone expansion viewed from L1, 15°, 30°*

Credit: R. Susino

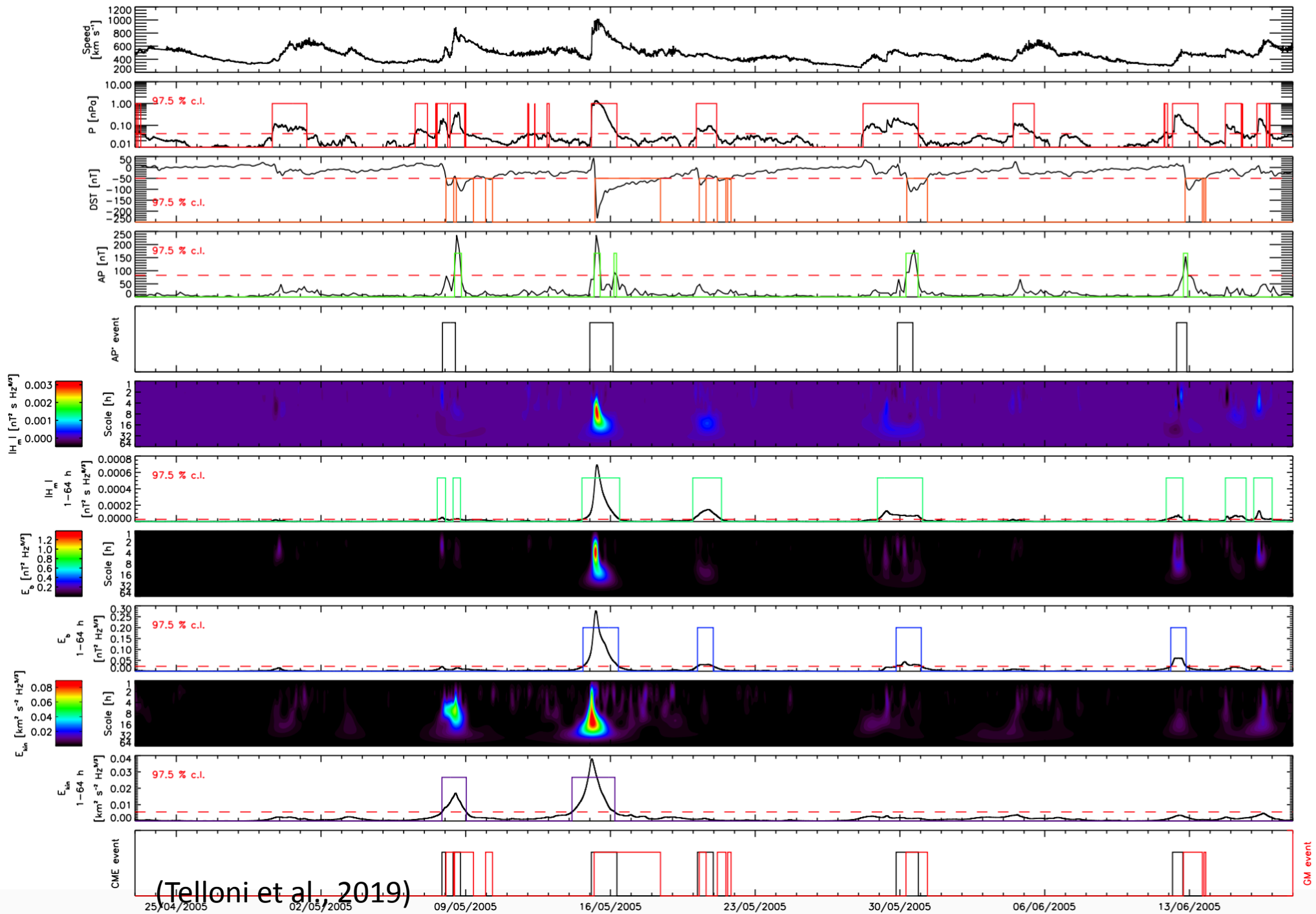

(Telloni et al, 2019)



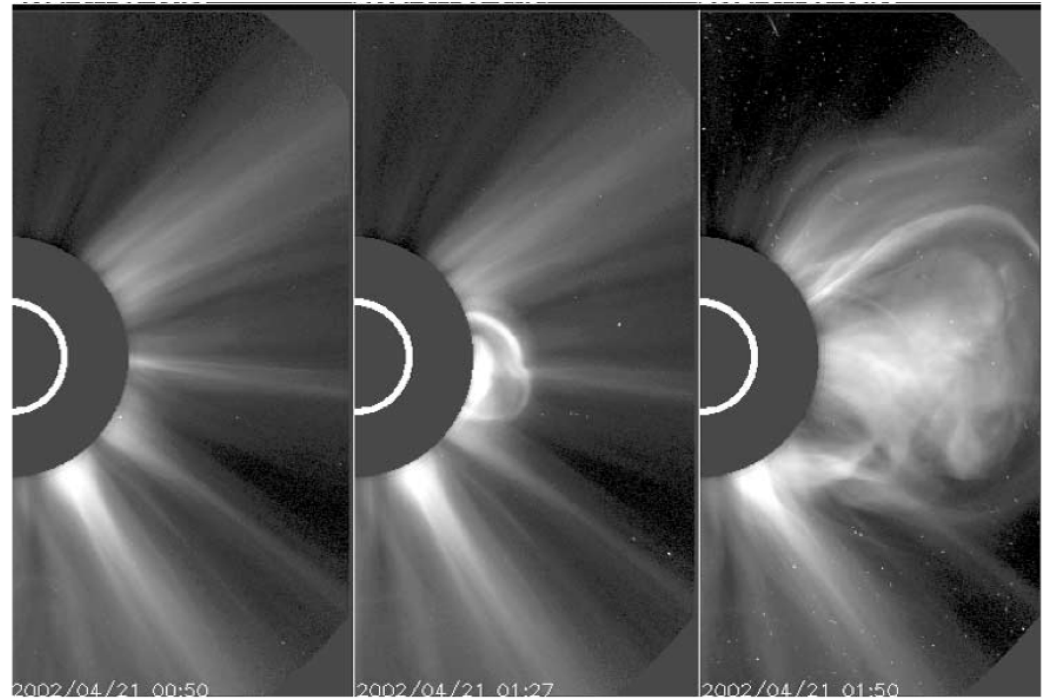
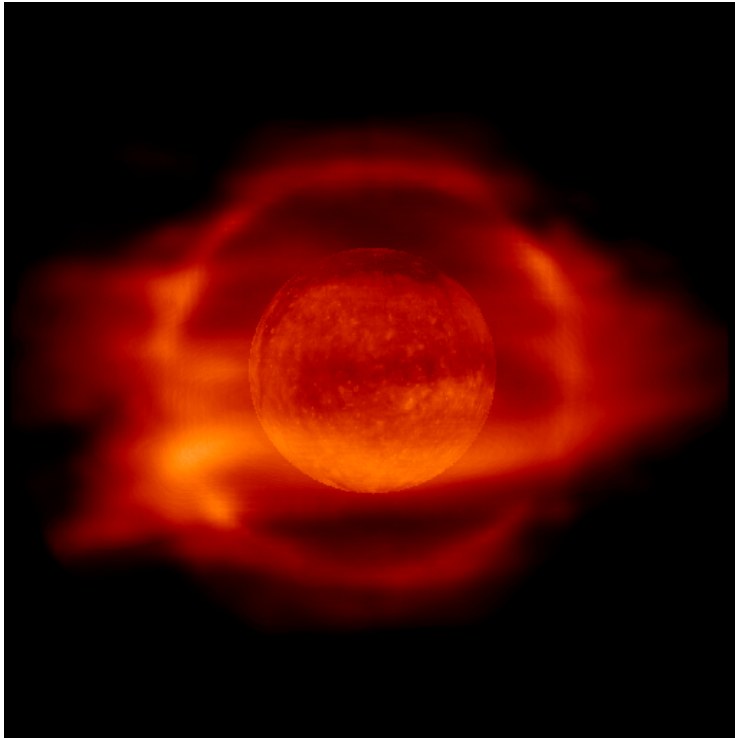

‘Freezing’ the corona at the limb in quasi-corotation allows the observation of the magnetic field evolution prior to coronal mass ejections and thus possibly the identification of the physical process originating them.

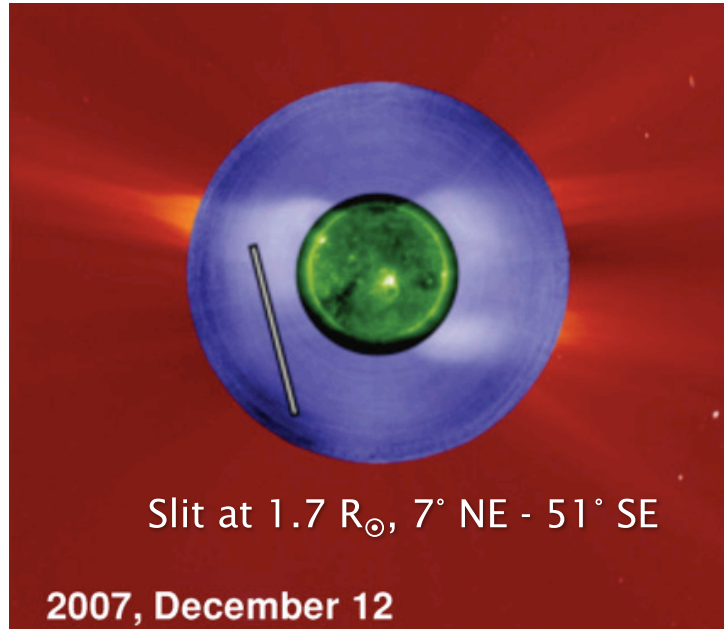

Maintain magnetic link of the heliospheric plasma to the source,  
disentangle the plasma intrinsic evolution and solar rotation effects  
link the plasma parameters to the evolution of the solar source.

Example of corotation vs. propagation

Persistent,  $\langle \alpha \rangle = 2.36$ , coronal density fluctuations (few hours to a few days period); if corotating structures, spatial scale  $\geq 3 \times 10^4$  km, photospheric supergranulation scale

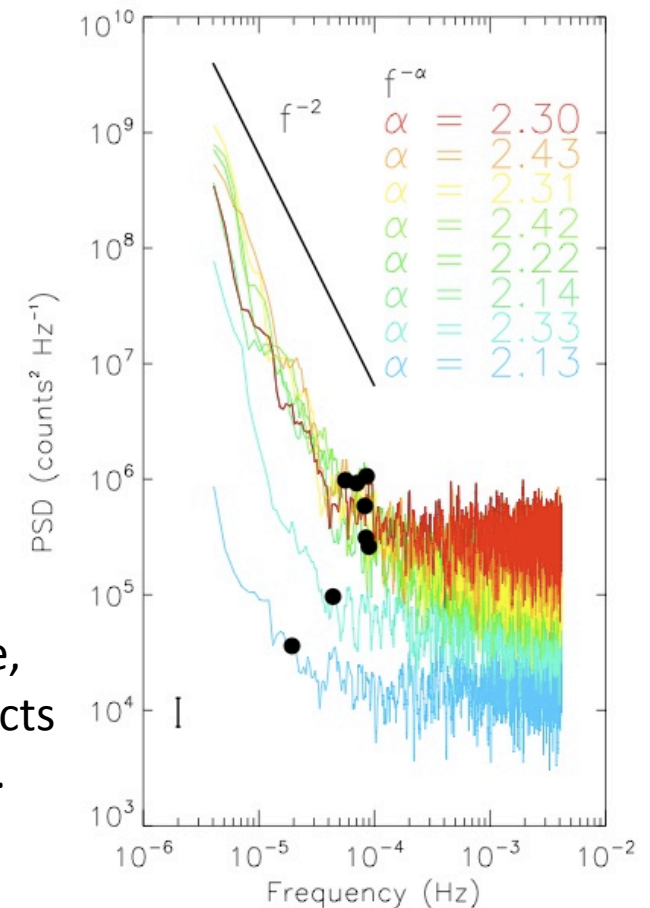

*Power spectra of HI Ly $\alpha$   
51° SE (blue) to 7° NE (red)  
(Telloni et al., 2009)*

# Solar Orbiter mission profile

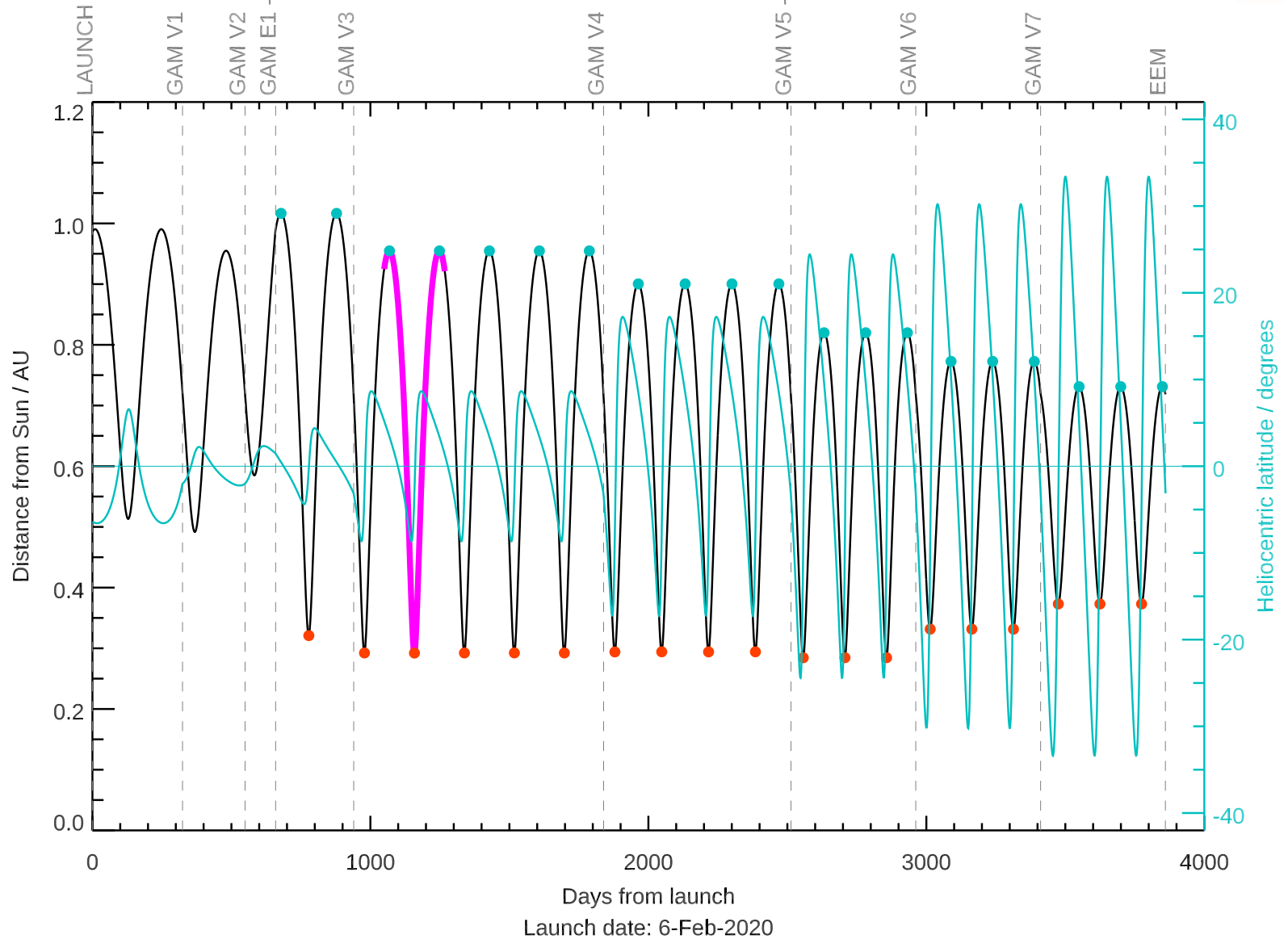

# Remote Sensing Windows and Synoptic Observations

Perihelion date: 10-Jan-2023

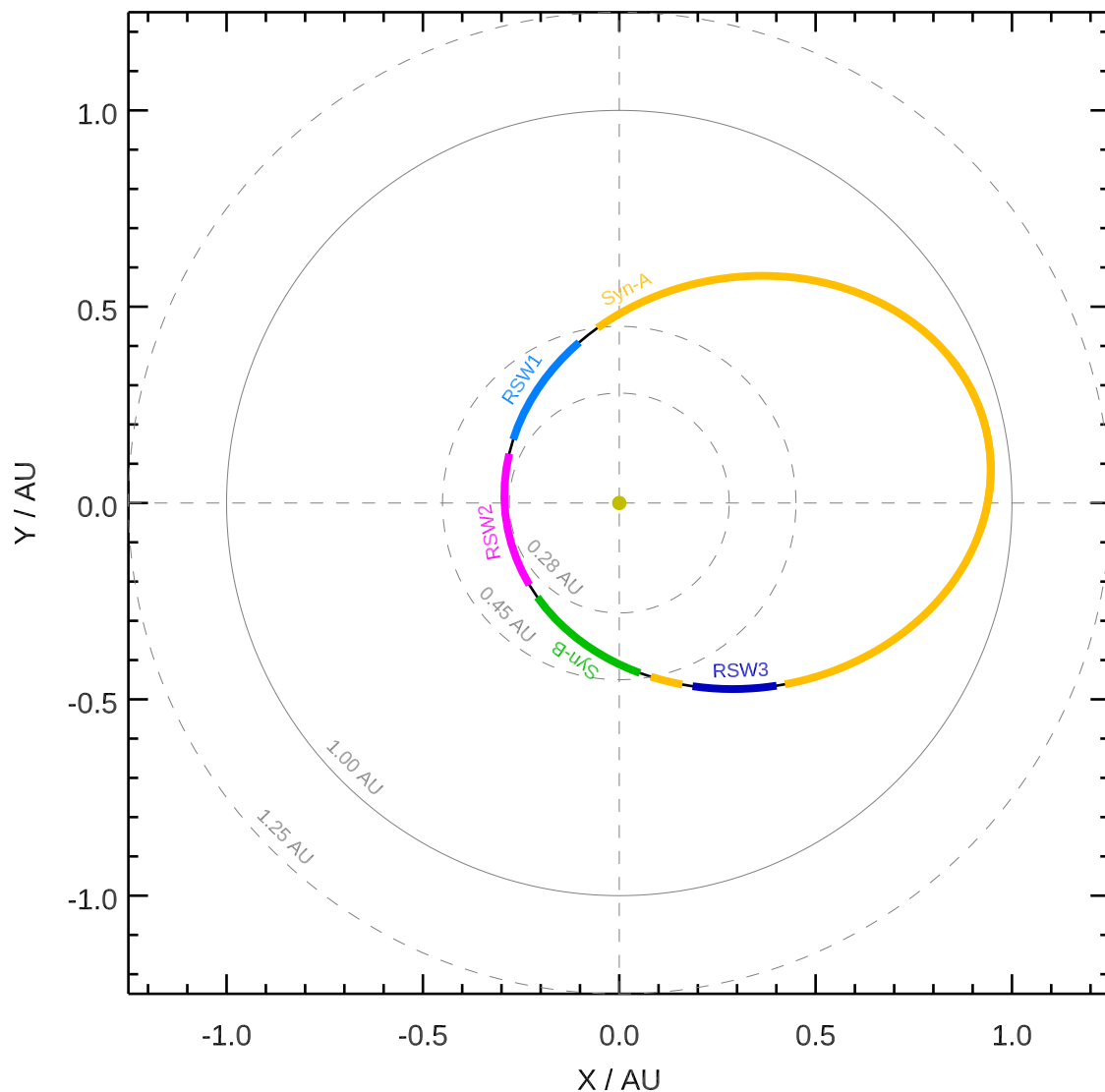

Syn-A, mean dist.: 0.90 AU

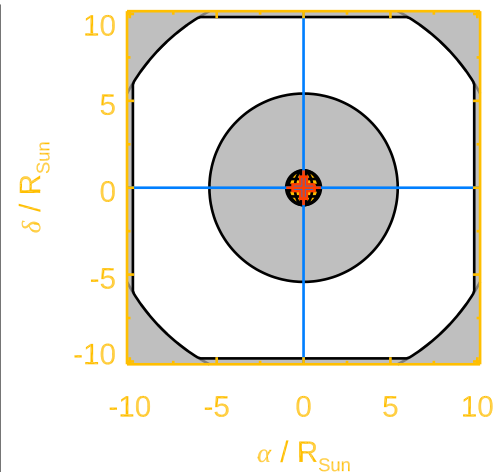

Syn-B, mean dist.: 0.39 AU

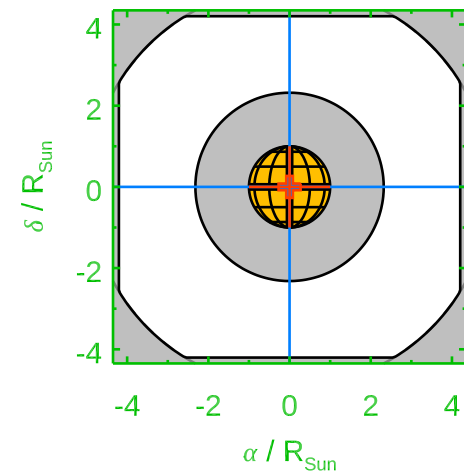

Wavelength range:	580 – 640 nm (polarized VL) HI 121.6 ± 10 nm (UV)
Field-of-view (square)	1.6° - 2.9°/3.4°
Spatial Plate Scale	10 arcsec (VL) 20 arcsec (UV)
Angular resolution	≤20 arcsec (VL) ≥80 arcsec (UV analog)
Instrumental Stray Light	VL < 10 <sup>-9</sup> UV < 10 <sup>-7</sup>
Cadence	≥ 1 sec fluctuation detection ≥ 1 min CME ≥ 5-10 min streamers/solar wind
Mass	24.55 kg
<b>Total data volume</b>	<b>27.2 Gb per orbit</b>

# Metis-Solar Orbiter and ASPIICS-PROBA3 Synergy



ASPIICS coronagraph (PROBA-3, ESA, formation flying technology demonstrator mission) includes:

1. telescope on the main spacecraft
  2. occulting disk on the smaller spacecraft, 150 m apart (separation between the two spacecraft to mm and arc second precision).
- Orbit duration (highly elliptical Earth orbit) 19h38min
  - Formation flying phase 6 h (coronal observations)
  - FoV  $1.08-3.0 R_{\odot}$
  - 1 year of overlap for coordinated observations with Solar Orbiter and Solar Probe Plus.

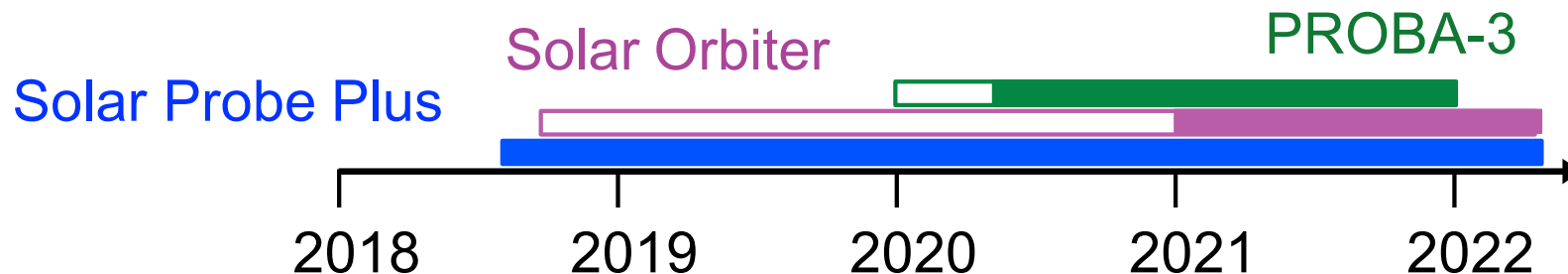
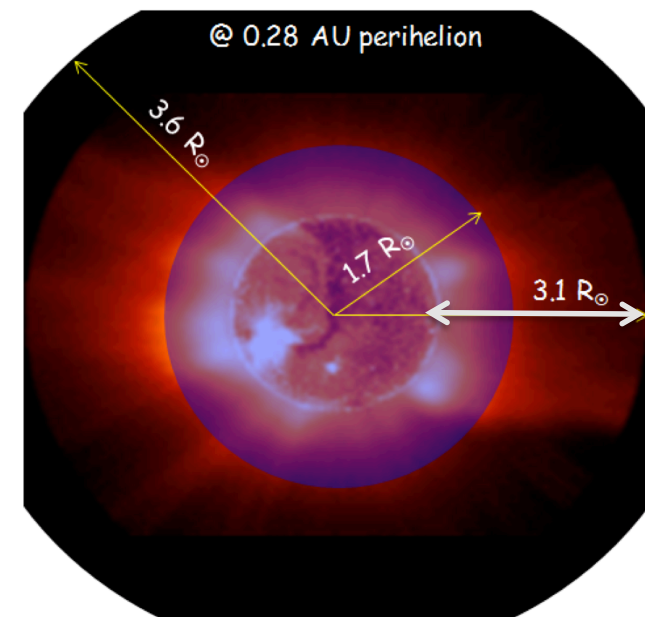

# Coronal structuring and dynamics from the solar surface

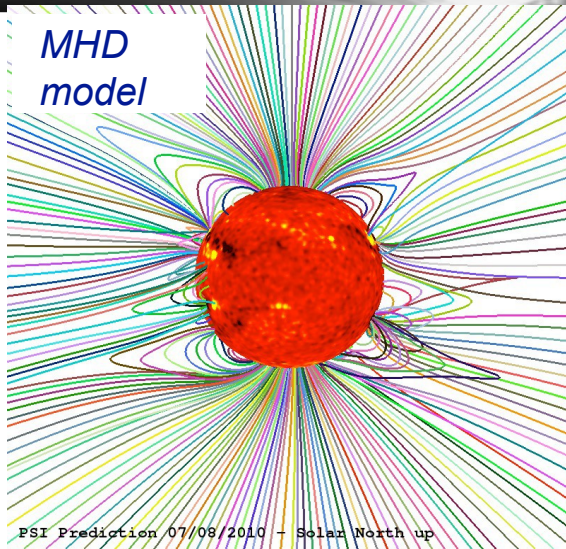

Transition between closed-field regions (magnetic field dominated) and open-field regions (solar wind dominated)

Connectivity of coronal structures back to the solar surface, in combination with state-of-the-art MHD models)

Constrain the models of the coronal and interplanetary magnetic field, i. e. to determine the connectivity of field lines sampled by Solar Orbiter in situ instruments (Sun-heliosphere connection)

# CME onset and acceleration

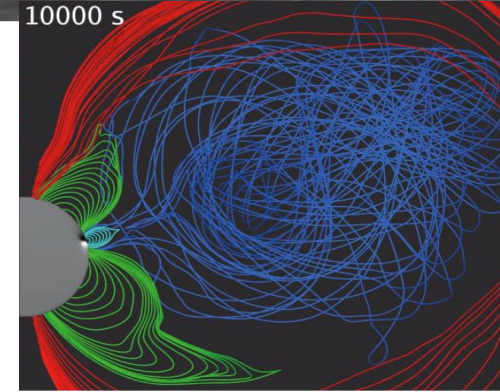
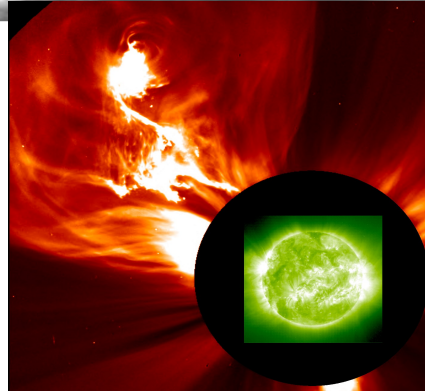
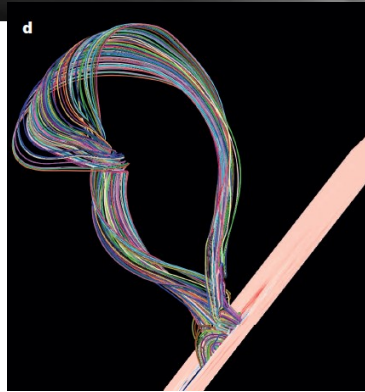

*torus instability*

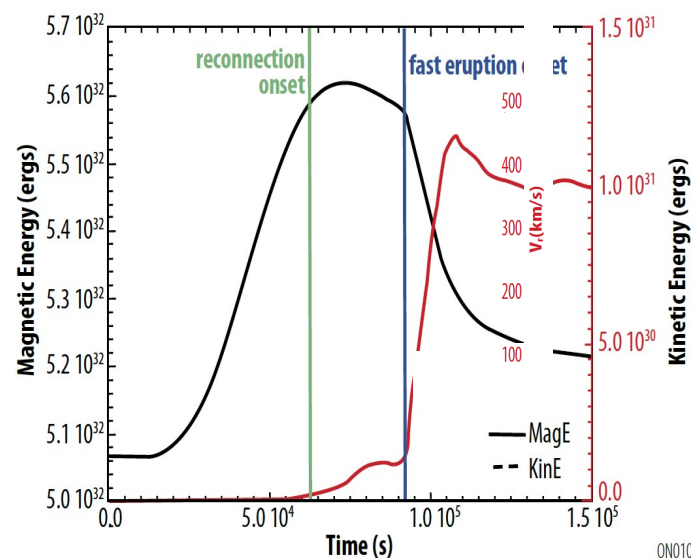
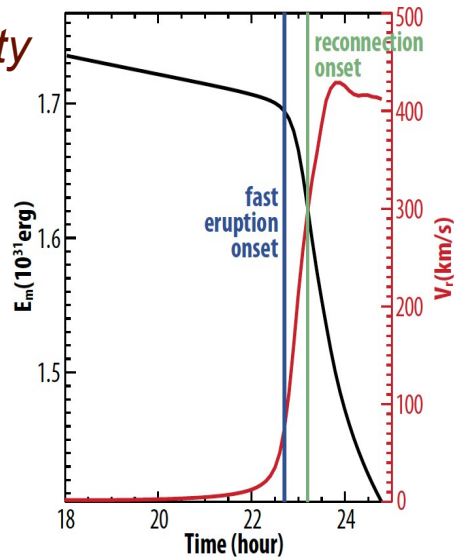

*magnetic breakout*

Observe dynamics of both the CME and the shock in the inner corona, providing us with conclusive evidence for the origin of coronal ejections and shock waves.



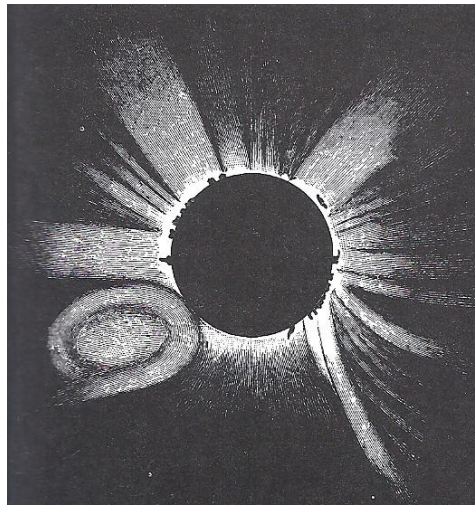

1860 E.W.L. Temple



Skylab 1973

*Solar Orbiter*  
2020-2030

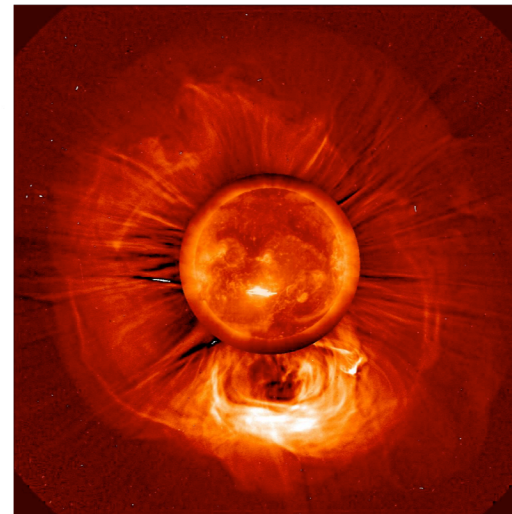
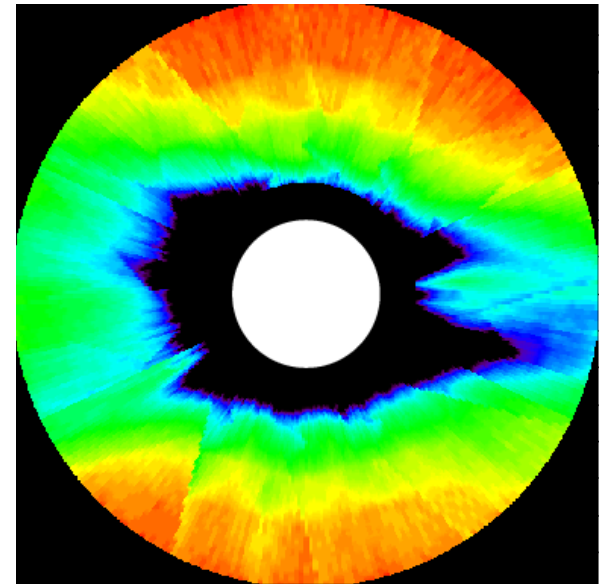

SOHO  
Cycle 23-24

# *Metis Team*

Metis Team funded by the Italian Space Agency (ASI & INAF))  
Max Planck Institut für Sonnensystemforschung (detectors)  
Institute of Astronomy, Czech Academy of Science and Toptec (mirrors)

## Industrial Team (Italy)

OHB Italia, Milan

Thales Alenia Space – Turin

## HW Team (Italy)

University of Florence

INAF – Turin Astrophysical Observatory

University of Padua

CNR-IFN Padua

INAF – Capodimonte Astrophysical Observatory, Naples

INAF – Catania Astrophysical Observatory

INAF -IASF Milan

University of Urbino