

This pdf was circulated in
Volume 4, Number 116,
on 5 November 2012.

The following are

- (1) Abstract for the UNBSSI PowerPoint presentation at UN/Ecuador Workshop on ISWI.
- (2) The presentation itself.

UNITED NATIONS PROGRAMME ON SPACE APPLICATIONS

United Nations Basic Space Science Initiative (UNBSSI) 1991-2012

S. Gadimova and H.J. Haubold, Office for Outer Space Affairs, United Nations, Vienna International Centre, Vienna, Austria, Sharafat.Gadimova@unvienna.org

The UNBSSI is a long-term effort for the development of astronomy and space science through regional and international cooperation in this field on a worldwide basis, particularly in developing nations. UNBSSI workshops are co-sponsored and co-organized by ESA, JAXA, and NASA.

A series of workshops on BSS was held from 1991 to 2004 (India 1991, Costa Rica and Colombia 1992, Nigeria 1993, Egypt 1994, Sri Lanka 1995, Germany 1996, Honduras 1997, Jordan 1999, France 2000, Mauritius 2001, Argentina 2002, and China 2004; <http://neutrino.aquaphoenix.com/un-esa/>) and addressed the status of astronomy in Asia and the Pacific, Latin America and the Caribbean, Africa, and Western Asia. Through the lead of Professor Dr. Masatoshi Kitamura (1926-2012) from the National Astronomical Observatory Japan, astronomical telescope facilities were inaugurated in

seven developing nations and planetariums were established in twenty developing nations based on the donation of respective equipment by Japan.

Pursuant to resolutions of the United Nations Committee on the Peaceful Uses of Outer Space (UNCOPUOS) and its Scientific and Technical Subcommittee, since 2005, these workshops focused on the preparations for and the follow-ups to the International Heliophysical Year 2007 (UAE 2005, India 2006, Japan 2007, Bulgaria 2008, South Korea 2009;

<http://www.unoosa.org/oosa/SAP/bss/ihy2007/index.html>). IHY's legacy is the current operation of 16 worldwide instrument arrays with close to 1000 instruments recording data on solar-terrestrial interaction from coronal mass ejections to variations of the total electron content in the ionosphere (<http://iswi-secretariat.org/>). Instruments are provided to hosting institutions by entities of Armenia, Brazil, France, Israel, Japan, Switzerland, and the United States.

Starting in 2010, the workshops focused on the International Space Weather Initiative (ISWI) as mandated in a three-year-work plan as part of the deliberations of UNCOPUOS. Workshops on ISWI were scheduled for Egypt in 2010 for Western Asia, Nigeria in 2011 for Africa, and Ecuador in 2012 for Latin America and the Caribbean. The latter one was held from 8-12 October 2012 at the Astronomical Observatory of Quito (<http://oaq.epn.edu.ec/iswi/index.html>). This workshop will review the results of the operation of the above instrument arrays and will discuss ways and means to continue space weather research and education, particularly focusing on programmes as implemented by the International Center for Space Weather Science and Education at Kyushu University, Fukuoka, Japan (http://www.serc.kyushu-u.ac.jp/index_e.html), which was established through the UNBSSI in 2012. Similar research and education centers were also established in Nigeria (<http://www.cbssonline.com/aboutus.html>) and India (<http://www.cmsintl.org/>).

Activities of UNBSSI are also coordinated with the Regional Centres for Space Science and Technology Education, affiliated to the United Nations (<http://www.unoosa.org/oosa/en/SAP/centres/index.html>) and the International Committee on Global Navigation Satellite Systems (<http://www.unoosa.org/oosa/en/SAP/gnss/icg.html>).

Further Reading:

W. Wamsteker, R. Albrecht, and H.J. Haubold (Eds.): *Developing Basic Space Science World-Wide: A Decade of UN/ESA Workshops*, Kluwer Academic Publishers, Dordrecht/Boston/London 2004.

B.J. Thompson, N. Gopalswamy, J.M. Davila, and H.J. Haubold (Eds.): *Putting the "I" in IHY: The United Nations Report for the International Heliophysical Year 2007*, Studies in Space Policy Volume 3, Springer, Wien/New York 2009.

K. Yumoto (Ed.): *Selected Papers of MAGDAS for ISWI/MAGDAS School on Litho-Space Weather, 15-20 August 2011*, International Center for Space Weather Science and Education, Kyushu University, Fukuoka, Japan, 2012, pp. 264.



UNITED NATIONS
Office for Outer Space Affairs



United Nations Basic Space Science Initiative
International Heliophysical Year 2007
International Space Weather Initiative

Sharafat Gadimova and Hans Haubold

United Nations Office at Vienna
Office for Outer Space Affairs
Space Applications Section

United Nations/Ecuador Workshop on the International Space Weather Initiative

08 – 12 October 2012

Quito, Ecuador



Workshops on Basic Space Science (1991 – 2004)

The status of astronomy in Asia and the Pacific, Latin America and the Caribbean, Africa, and Western Asia were addressed in the following series of workshops:

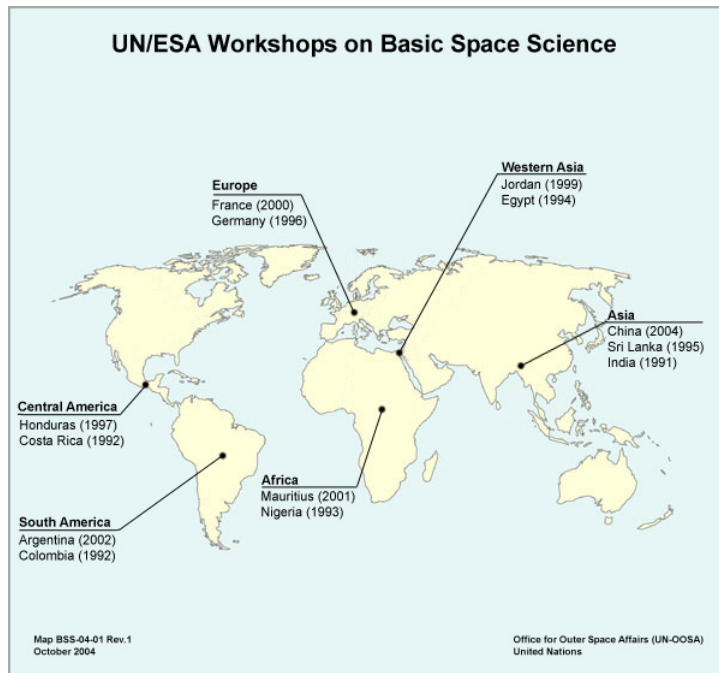

■ **Regional:**

India (1991), Costa Rica (1992), Colombia (1992), Nigeria (1993), Egypt (1994)

■ **Inauguration of optical telescopes:**

Sri Lanka (1995), Honduras (1997), Jordan (1999)

■ **International:**

Germany (1996), France (2000), Mauritius (2001), Argentina (2002)

■ **Review of all workshops:**

P.R. China (2004)

Website: <http://neutrino.aquaphoenix.com/un-esa/>



UNITED NATIONS
Office for Outer Space Affairs



Workshops on Basic Space Science (BSS): 1991 – 2004

- ◆ Through the Official Development Assistance (ODA) of Japan **astronomical telescope facilities** were inaugurated in 7 developing nations, and **planetariums** in 20 developing nations
- ◆ Teaching material, hands-on astrophysics material, and variable star observing programmes had been developed for the operation of such astronomical telescope facilities in an university environment: **basic space science TRIPOD concept**

BSS TRIPOD: Telescope, Observing, Teaching

- ◆ **Equipment: astronomical telescope**
 - ◆ National Astronomical Observatory Japan (NAOJ), Government of Japan
- ◆ **Data taking and analysis: observing programmes**
 - ◆ American Association of Variable Star Observers (AAVSO)
- ◆ **Teaching: astrophysics for university physics courses**
 - ◆ International Astronomical Union (IAU)



UNITED NATIONS
Office for Outer Space Affairs

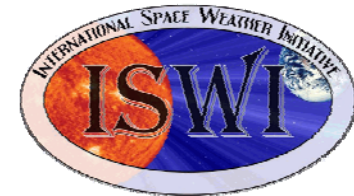

Workshops on Basic Space Science (1991 – 2004):

BSS TRIPOD –Telescope, Observing, Teaching

- **Government of Japan (NAOJ): Japanese Cultural Grant Aid**

- 45cm reflecting telescope
- CCD & computer equipment
- Building/ dome/ maintenance provided by local institution
- Singapore 1987, Indonesia 1988, Thailand 1989, Sri Lanka 1995, Paraguay 1999, The Philippines 2000, Chile 2001, Mongolia 2008

- **American Association of Variable Star Observers (AAVSO):**

- Hands-on Astrophysics
- Setting Up a Variable Star Observing Programme
- Astronomy, mathematics, computer science

- **International Astronomical Union (IAU): Astrophysics for University Physics Courses**

- Study/ comparison of university education curricula in developing countries
- Elementary calculus
- Classical and Statistical mechanics
- Thermodynamics applied to astronomy





UNITED NATIONS
Office for Outer Space Affairs



Workshops on Basic Space Science (1991 – 2004):

Planetariums

- **Government of Japan: National Astronomical Observatory Japan**
- **Host country**
- **United Nations Office for Outer Space Affairs**
 - **Myanmar (1986), Jordan, Malaysia, the Philippines, India, Argentina, Uruguay, Vietnam (1998), Thailand, Sri Lanka, Uzbekistan, Paraguay, Ecuador, Honduras, Costa Rica, Peru (2003), Bolivia, Cuba, El Salvador (2007)**



Myanmar 1986



Peru 2003



Viet Nam 1998

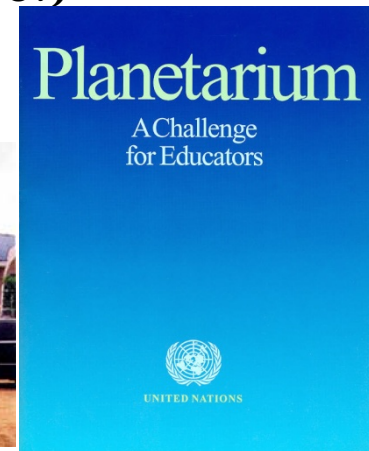

Workshops on Basic Space Science (1991 – 2004):

Planetariums

Over 25 years of commitments by Japanese Government





UNITED NATIONS
Office for Outer Space Affairs



Workshops on Basic Space Science (1991 – 2004):
Final Report: Developing Basic Space Science World-Wide

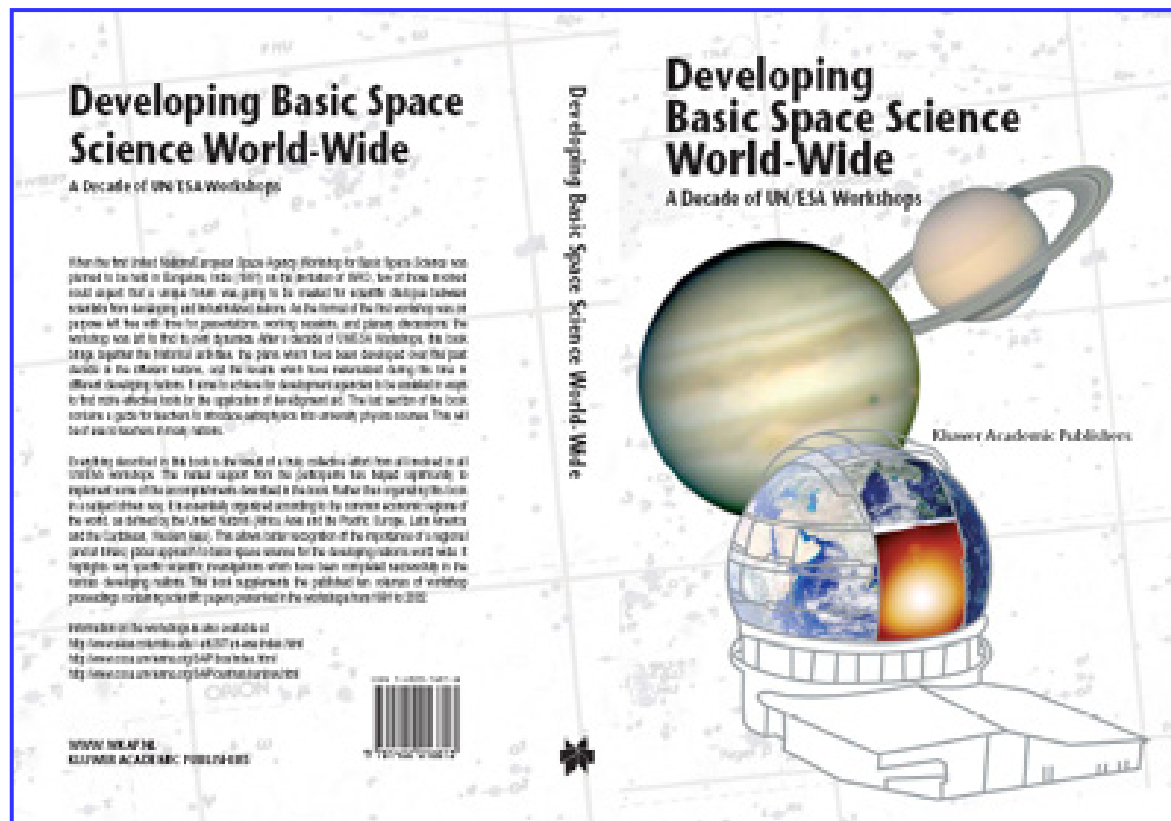

- **40 workshop follow-up projects**
- **70 scientists and engineers**
- **Regionally and internationally**



UNITED NATIONS
Office for Outer Space Affairs



Workshops on International Heliophysical Year 2007 (IHY): 2005– 2009

Advancing understanding of the heliospherical processes that govern the Sun, Earth, and Heliosphere, and demonstrating the beauty, relevance, and significance of space and Earth science to the world

◆ **2004: Session of UNCOPUOS called for addressing solar-terrestrial interaction: global climate, space weather, Sun-Earth-heliosphere-system**

◆ **Workshops: United Arab Emirates (2005), India (2006), Japan (2007), Bulgaria (2008), South Korea (2009)**

◆ **Outreach: flyers, posters, brochures, booklets**

◆ **Follow-up projects:**

- ◆ **Low-cost, ground-based world-wide instrument arrays**
- ◆ **ADS**
- ◆ **Virtual observatories**
- ◆ **BSS TRIPOD - -> IHY TRIPOD**
- ◆ **GNSS on board of instrument arrays**

The collage contains several key documents and graphics:

- UN General Assembly Resolution:** A document titled 'Resolution 60/10 on the United Nations Decade of Education for Sustainable Development (2005-2014)', which includes a section on the International Heliophysical Year 2007.
- UN Basic Space Science Initiative Flyer:** A flyer with the UN logo and the text 'UN Basic Space Science Initiative for the International Heliophysical Year'. It includes a 'What is IHY?' section and a 'Contact Information' box.
- 'What is IHY?' Brochure:** A detailed brochure explaining the International Heliophysical Year (IHY) 2007. It discusses the goals of IHY, the scientific objectives, and the opportunities for involvement. It features a large image of the Earth and Sun.
- IHY 2007 Logo:** A graphic with the text 'IHY 2007' and Arabic text: 'الهيئة العامة للغذاء والدواء' and 'مشاركة الأبحاث العلمية في الدراسات العلمية الدولية'.



UNITED NATIONS
Office for Outer Space Affairs



Workshops on International Heliophysical Year 2007 (IHY): 2005– 2009

UNBSS TRIPOD - - > IHY TRIPOD

IHY TRIPOD: Instrument Array, Data, Teaching

- ◆ **2005: Deploying small inexpensive instruments** such as magnetometers, radio antennas, GPS receivers, particle detectors around the world to make global measurements of ionospheric, magnetospheric and heliospheric phenomena
 - ◆ **Partnerships** between instrument providers and instrument host nations
 - ◆ Provision of instrumentation by PI
 - ◆ Host institution makes available manpower, facilities, and operational support
 - ◆ **Data** taking, sharing, analysis, publication
 - ◆ **Teaching** space science at university level utilizing data

- ◆ ***Coordinated Investigation Programmes in disciplines: heliosphere and cosmic rays, solar, magnetospheres, ionized atmospheres, climate, astro/heliobiology***

**International Heliophysical Year 2007 (IHY2007) to
International Year of Astronomy 2009 (IYA 2009)
UNGA 62/200 of 2007**



UNITED NATIONS
Office for Outer Space Affairs

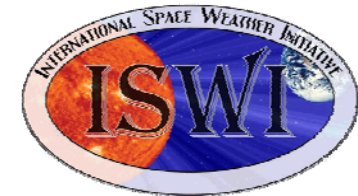

Workshops on International Heliophysical Year 2007 (IHY): 2005– 2009

Final Report IHY

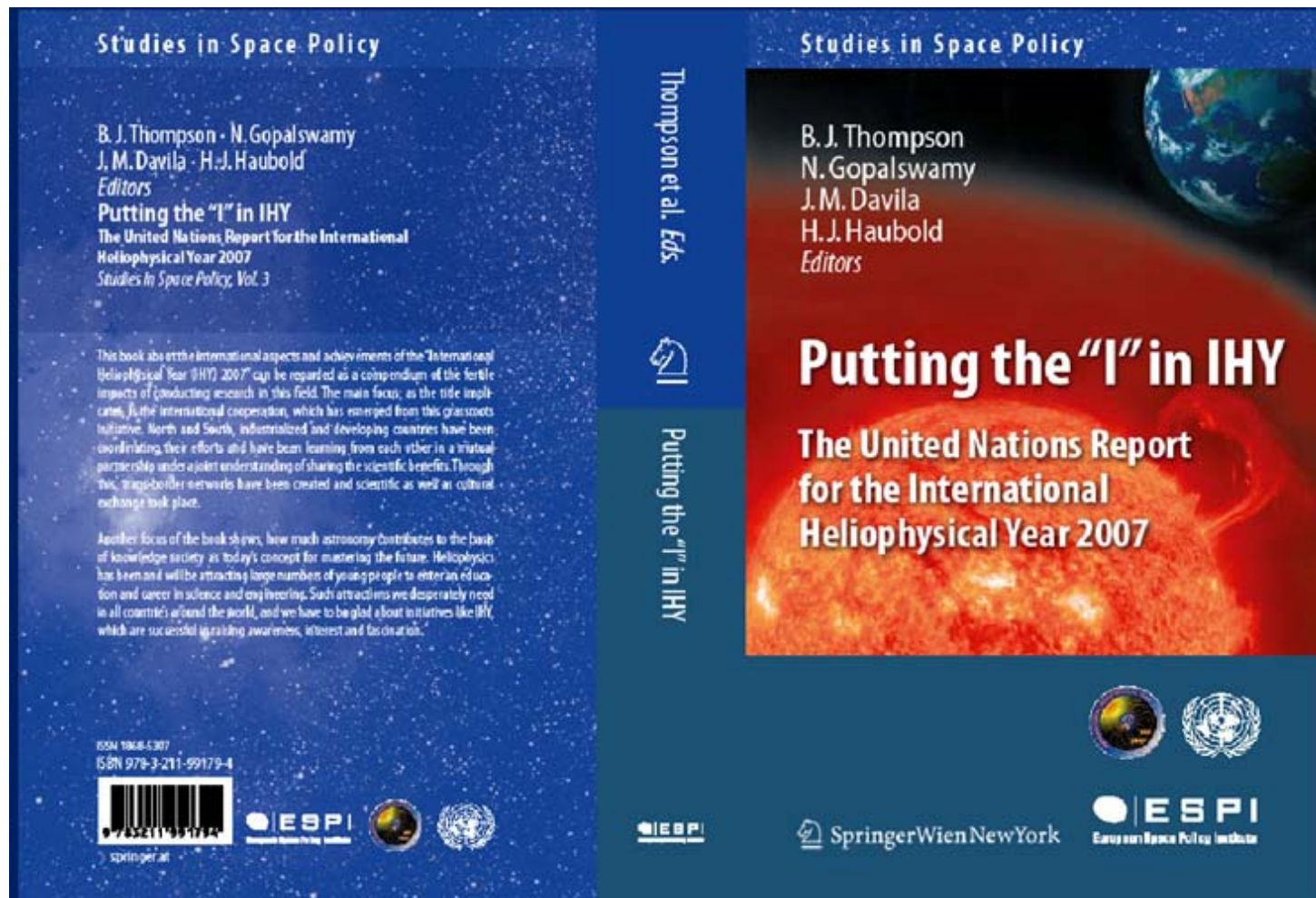

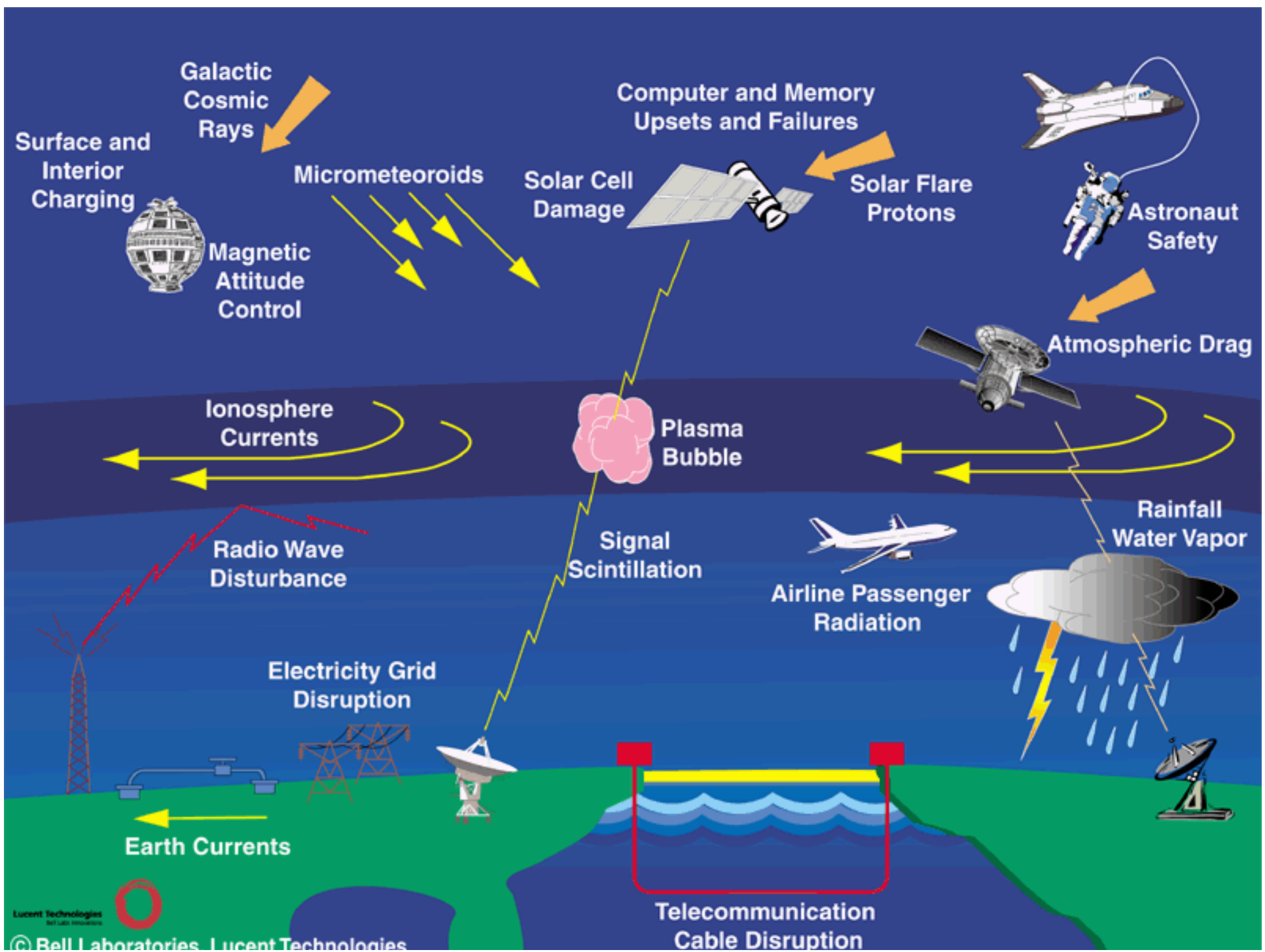



UNITED NATIONS
Office for Outer Space Affairs



Workshops on International Space Weather Initiative (ISWI): 2010– 2012

2010: The Workshops focused on the International Space Weather Initiative as mandated in a three-year work-plan as part of deliberation of the United Nations Committee on the Peaceful Uses of Outer Space.

- ◆ **Workshops: Egypt (2010), Nigeria (2011), Ecuador (2012)**
 - ◆ **Review** the results of the operation of the instrument arrays
 - ◆ **Discuss** ways and means to continue space weather research and education, particularly focusing on programmes as implemented by the **International Centre for Space science and Education at Kyushu University, Fukuoka, Japan**
 - ◆ **Similar research centres and education centres were also established in Nigeria and India**

MAGDAS/CPMN

(MAGnetic Data Acquisition System/Circum-pan Pacific Magnetometer Network)

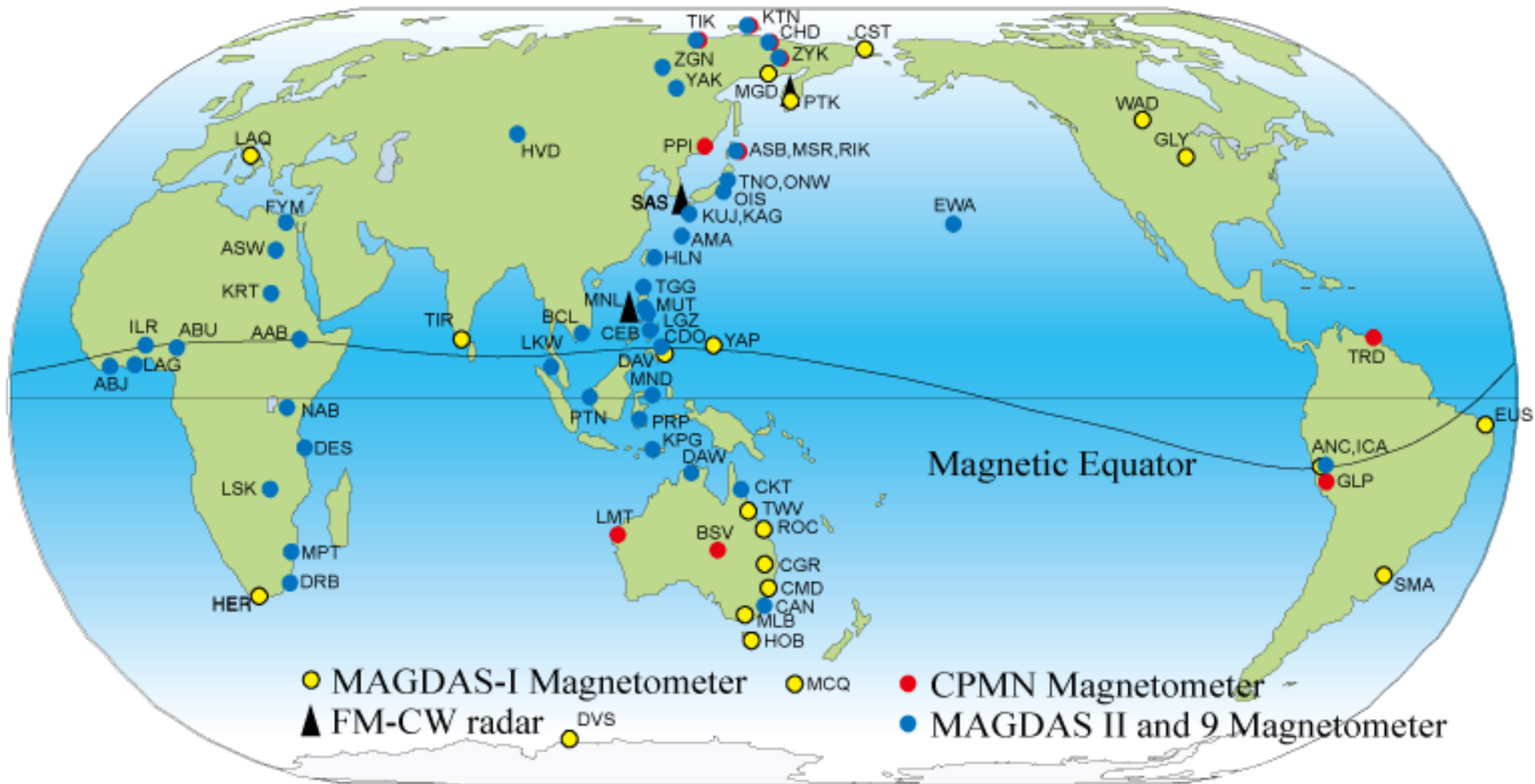

Location of the 64 MAGDAS stations

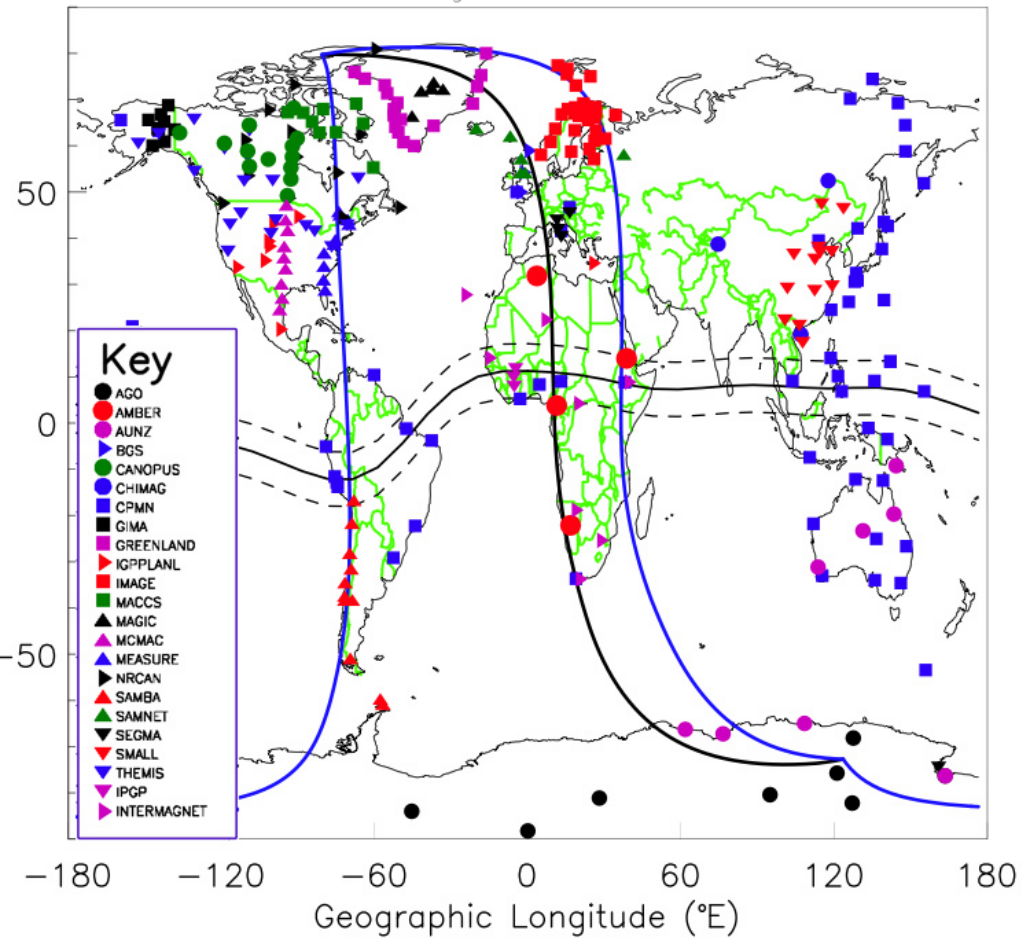
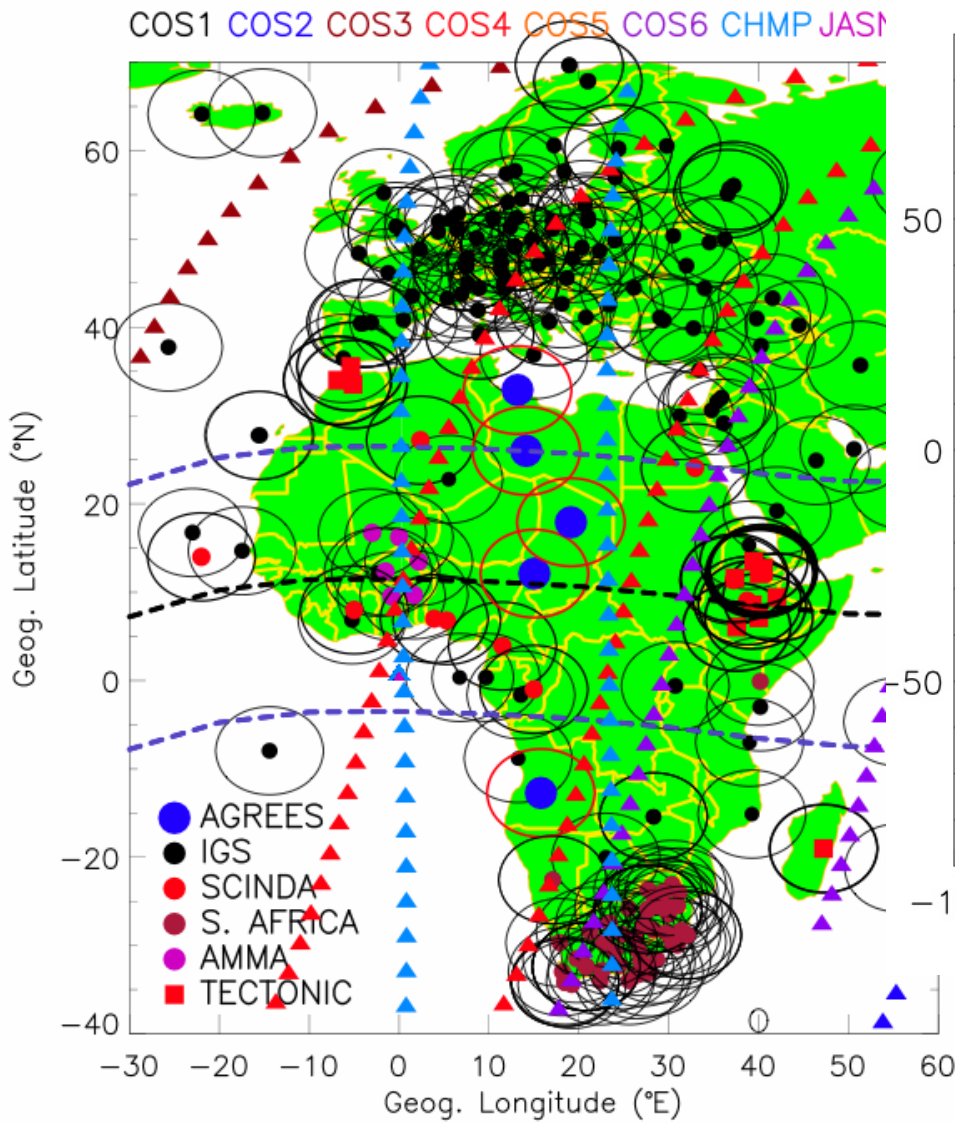

GPS Network and AMBER Mags

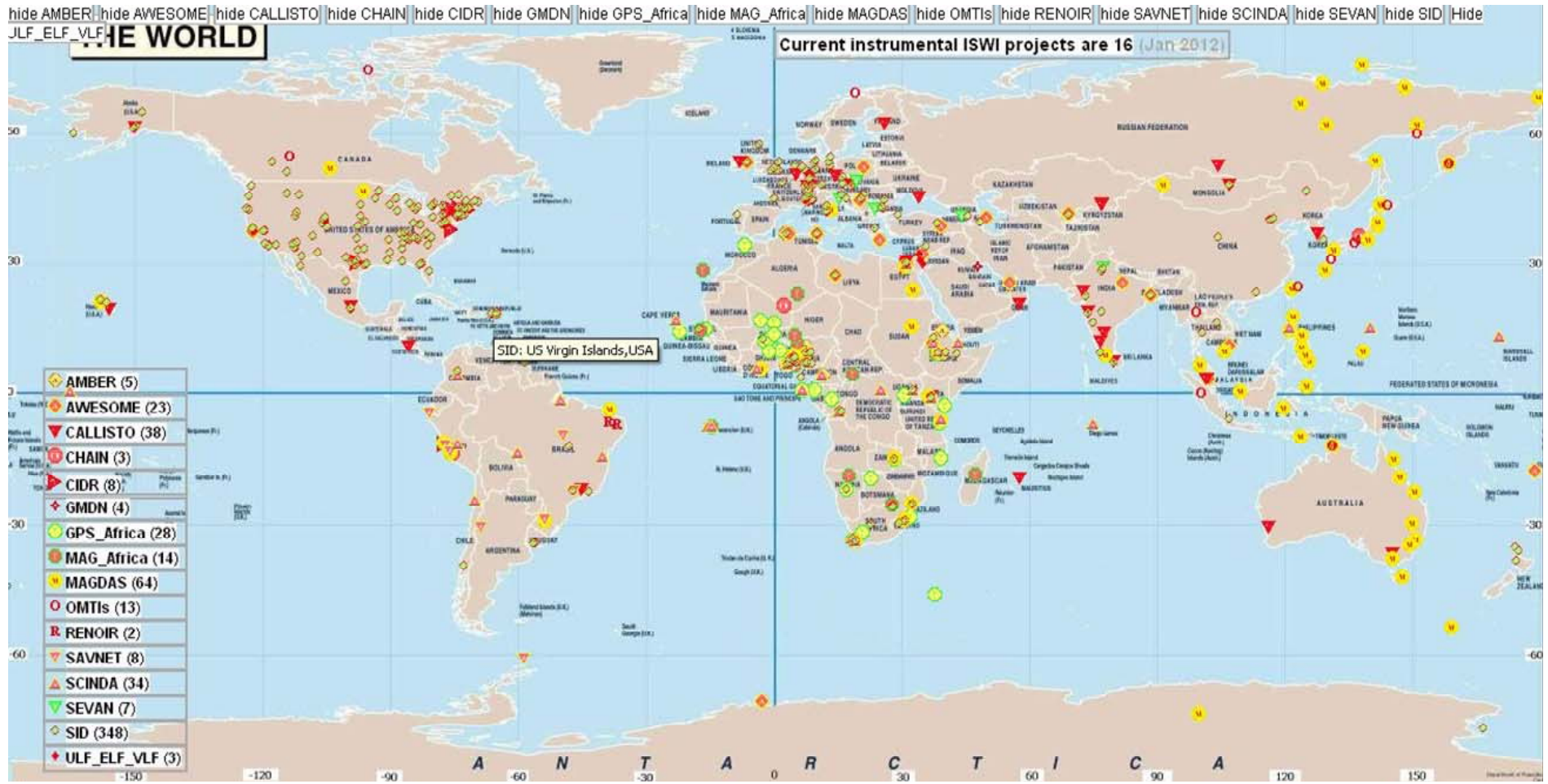

ISWI 2012: 16 + 2 Instrument Arrays

Instrument Programme

Sudden Ionospheric Disturbance Monitor (SID) operated by UNOOSA

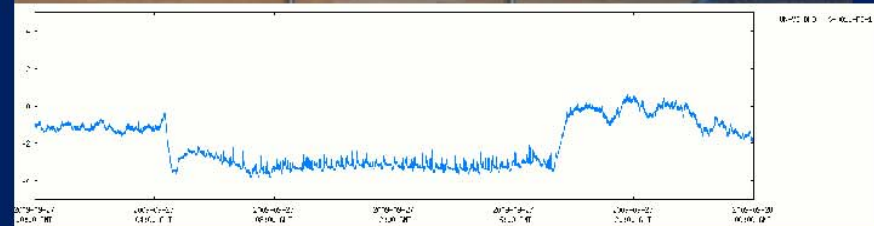
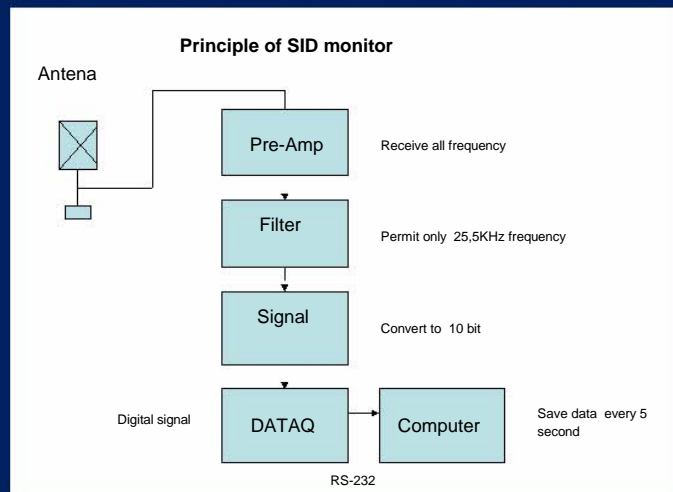

International Space Weather Initiative



UNITED NATIONS
Office for Outer Space Affairs



Information Dissemination and Capacity Building

Training for capacity building in developing countries:

provide support to the regional centres for space science and technology education, affiliated to the United Nations, which also act as the ICG Information Centres

- ◆ ***Africa: Morocco and Nigeria***
- ◆ ***Latin America and the Caribbean: Brazil and Mexico***
- ◆ ***Asia and the Pacific: India***
- ◆ ***Western Asia: Jordan (2011)***
- ◆ ***Remote Sensing & GIS, Satellite Meteorology & Global Climate, Satellite Communications, Space & Atmospheric Science and **Global Navigation Satellite Systems (in development)*****





UNITED NATIONS
Office for Outer Space Affairs



**United Nations Office for Outer Space Affairs
PO Box 500, 1400 Vienna, Austria**

Phone: +43 1 26060 4951

Fax: +43 1 26060 5830

E-mail: ooa@unvienna.org

Web: <http://www.unoosa.org>